

Chapter 28
Magnetic fields
Masatsugu Sei Suzuki,
Department of Physics, SUNY at Binghamton
(Date: August 15, 2020)

1. Definition of magnetic field

We define the magnetic field \mathbf{B} , in the following way, based on the observations

$$\mathbf{F} = q(\mathbf{v} \times \mathbf{B}) \quad (1)$$

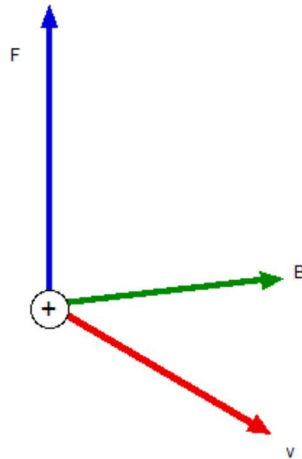

Right-hand rule

Use the right-hand rule to find the direction of \mathbf{F} , as follows: Point your right fingers along \mathbf{v} . Curl your fingers toward \mathbf{B} . Your right thumb will point along \mathbf{F} .

A particle with a positive charge q moving with velocity \mathbf{v} through a magnetic field \mathbf{B} experiences a magnetic detecting force \mathbf{F} .

Eq.(1) serves as the definition of \mathbf{B} .

The direction of magnetic field:



out of page

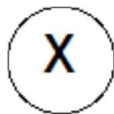

into the page

Direction of magnetic field

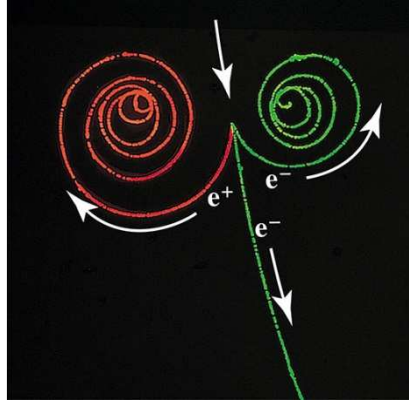

Motion of electron (-e) and positron (+e).

2. Unit of B

$$F = qvB$$

$$[N] = [C][m/s][B]$$

or

$$[B] = [T] = \frac{[N]}{[C][m/s]} = \frac{[N]}{[A][m]}$$

Note that $[A] = [C/s]$

$$1\text{T} = 10^4 \text{ gauss}$$

$$1 \text{ gauss} = 1 \text{ Oe.}$$

((Nikola Tesla))

Nikola Tesla (Serbian Cyrillic: Никола Тесла) (10 July 1856 – 7 January 1943) was an inventor, physicist, mechanical engineer, and electrical engineer. Tesla is best known for his many revolutionary contributions to the discipline of electricity and magnetism in the late 19th and early 20th century. Tesla's patents and theoretical work formed the basis of modern alternating current electric power (AC) systems, including the polyphase power distribution systems and the AC motor, with which he helped usher in the Second Industrial Revolution. Contemporary biographers of Tesla have deemed him "the man who invented the twentieth century" and "the patron saint of modern electricity."

The SI unit measuring the magnetic field B , the tesla, was named in his honour (at the *Conférence Générale des Poids et Mesures*, Paris, 1960).



3. Typical values of B

Surface of a neutron star	10^8 T
Pulsed magnet	300 T (6 μ s)
Hybrid magnet	30 – 45 T
Superconducting magnet	5 – 20 T (steady magnetic field)
Large electromagnet	2 T
Small bar magnet	10^{-2} T = 100 Oe
Binghamton, NY, U.S.A. (Earth field)	3×10^{-5} T = 0.3 Oe
In a magnetically shielded room	10^{-14} T

4. Circular motion in a uniform magnetic field

4.1 Cyclotron frequency

Suppose that a particle (mass m and charge q) moves perpendicular to a uniform magnetic field; $F = qvB$. This force will provide the centripetal force to make the particle move in a circle of radius, R .

$$F = m \frac{v^2}{R} = qvB, \quad mv = qBR$$

The cyclotron radius R is given by

$$R = \frac{mv}{qB}$$

The period T is given by

$$T = \frac{2\pi R}{v} = \frac{2\pi}{v} \frac{mv}{qB} = \frac{2\pi m}{qB}$$

The cyclotron frequency f_c is obtained as

$$f_c = \frac{1}{T} = \frac{qB}{2\pi m}$$

$$\omega_c = 2\pi f_c = \frac{qB}{m} \quad (\text{cyclotron angular frequency})$$

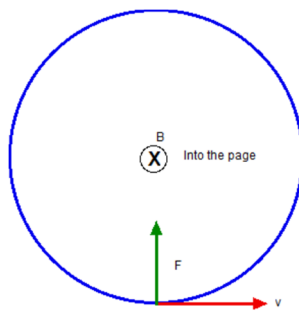

((**Note**)) ω_c is independent of v , or the kinetic energy of the particle.

4.2 Helical path

A charged particle having a velocity vector with a component parallel to a uniform magnetic field moves in a helical path.

The radius r_{\perp} of the helical path is related to the velocity perpendicular to \mathbf{B} as

$$r_{\perp} = \frac{mv_{\perp}}{qB}$$

The parallel component (v_{\parallel}) determines the pitch p of the helical path,

$$p = v_{\parallel} T = \frac{2\pi m}{qB} v_{\parallel}$$

where T is the period of the helical motion,

$$T = \frac{2\pi}{\omega_c} = \frac{2\pi m}{qB}$$

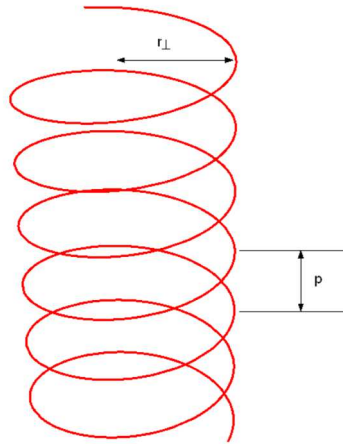
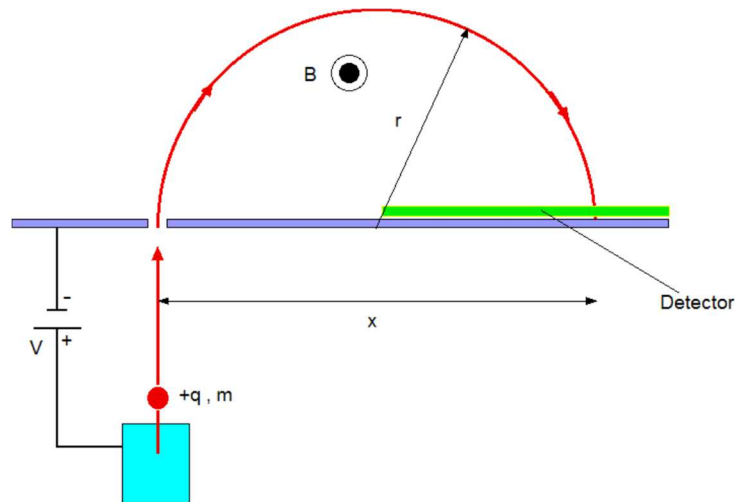

Fig. helical path which is drawn using ParametricPlot of the Mathematica. The particle has both the velocity parallel to \mathbf{B} and the velocity perpendicular to \mathbf{B} .

4.3 Mass spectrometer

The mass spectrometer is an instrument which can measure the masses and relative concentrations of atoms and molecules. It makes use of the basic magnetic force on a moving charged particle.



In this configuration, we have

$$\frac{1}{2}mv^2 = qV$$

$$F = qvB = \frac{mv^2}{r}$$

with

$$r = 2x .$$

Then the mass m is derived as

$$m = \frac{qr^2}{2V} B^2 = \frac{2qB^2}{V} x^2$$

B can be varied to cause different masses to hit the detector.

4.4 Cyclotron

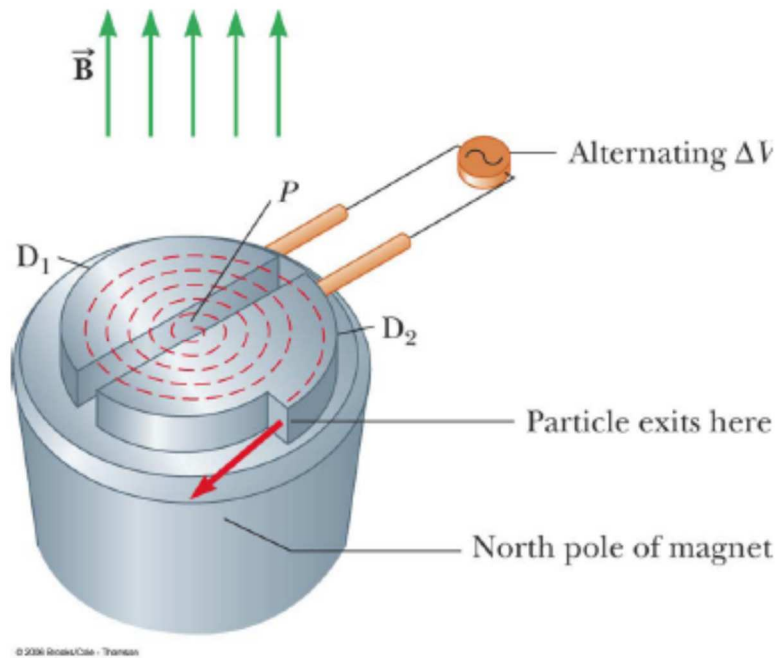

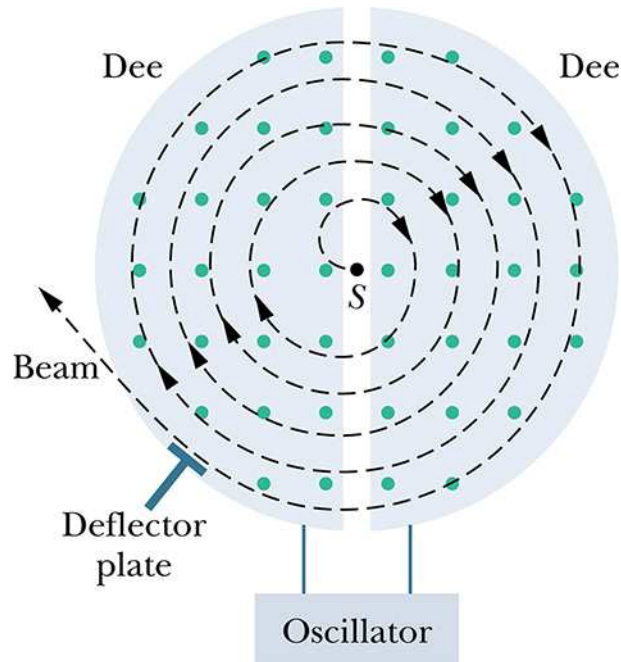

A cyclotron is a device that can accelerate charged particles to very high speeds. The energetic particles produced are used to bombard atomic nuclei and thereby produce reactions. D_1 and D_2 are called dees because of their shape. A high frequency alternating potential is applied to the dees. A uniform magnetic field is perpendicular to them. A positive ion is released near the center and moves in a semicircular path. The potential difference is adjusted so that the polarity of the dees is reversed in the same time interval as the particle travels around one dee. This ensures the kinetic energy of the particle increases each trip.

The cyclotron's operation is based on the fact that T is independent of the speed of the particles and of the radius of their path. When the energy of the ions in a cyclotron exceeds about 20 MeV, relativistic effects come into play.

$$\omega_c = \frac{qB}{m} = \omega \quad (\text{condition})$$

((**Note**)) Principle of cyclotron

We start with the Newton's second law for a circular motion of a particle with charge q and mass m in the presence of a constant magnetic field along the z axis,

$$F = m \frac{v^2}{r} = qvB$$

The radius r is obtained as

$$r = \frac{mv}{qB}$$

The angular frequency is

$$\omega = \frac{v}{r} = \frac{qB}{m}$$

which depends only on the magnetic field B .

We consider that the particle had negligibly small (almost zero) kinetic energy at the beginning. The kinetic energy that the particle with the charge q gains energy $2qV$, during the acceleration by the voltage of two Dees. The particle has to get through the two Dees, N times to reach the required kinetic energy K .

$$K = N(2qV)$$

In this case, the velocity of the particle will be

$$v = \sqrt{\frac{2K}{m}},$$

And the radius becomes

$$R = \sqrt{\frac{2Km}{q^2 B^2}}$$

since $K = \frac{1}{2}mv^2$ $K = \frac{1}{2}mv^2$.

((Example))

For proton ($q = e$, $m = 3.3435 \times 10^{-27}$ kg),

$$K = 16 \text{ MeV}, B = 1.5 \text{ T}, \quad R = 38.5 \text{ cm}, \text{ and } f = 22.87 \text{ MHz.}$$

$$K = 1 \text{ MeV}, B = 1.0 \text{ T}, \quad R = 14.45 \text{ cm}, \text{ and } f = 15.25 \text{ MHz.}$$

For electron ($q = e$, $m = 9.10938 \times 10^{-31}$ kg), $K = 0.5 \text{ MeV}$,

$$v = \sqrt{\frac{2K}{m_e}} = 4.1938 \times 10^8 \text{ m/s} > c.$$

See the Appendix for the relativistic case (synchrotron).

5. Kinetic energy of electrons in the presence of fields

5.1 $E = 0$ and $B \neq 0$

When a particle of charge q and mass m moves in a static magnetic field \mathbf{B} , then its kinetic energy is constant in time. The proof is given as follows. From the work energy theorem,

$$\Delta K = W = \mathbf{F} \cdot \Delta \mathbf{r}$$

or

$$\frac{dK}{dt} = \mathbf{F} \cdot \frac{d\mathbf{r}}{dt} = \mathbf{F} \cdot \mathbf{v} = q(\mathbf{v} \times \mathbf{B}) \cdot \mathbf{v}$$

where K is the kinetic energy, W is the work done, \mathbf{F} is the force and defined by

$$\mathbf{F} = q(\mathbf{v} \times \mathbf{B})$$

By the definition of a cross product, the vector $(\mathbf{v} \times \mathbf{B})$ is at right angle to \mathbf{v} . Then we have

$$\frac{dK}{dt} = 0$$

or K is constant in time. In other words, the kinetic energy is conserved.

((Note))

In the quantum mechanics, this is not true since the Hamiltonian is given by the Zeeman energy. This is related to the origin of magnetism, which arises from the quantum mechanics.

5.2 $\mathbf{E} \neq \mathbf{0}$ and $\mathbf{B} \neq \mathbf{0}$

$$\frac{dK}{dt} = \mathbf{F} \cdot \frac{d\mathbf{r}}{dt} = \mathbf{F} \cdot \mathbf{v} = q(\mathbf{E} + \mathbf{v} \times \mathbf{B}) \cdot \mathbf{v} = q(\mathbf{E} \cdot \mathbf{v})$$

Then the kinetic energy changes with time in the presence of the electric field \mathbf{E} .

6. Motion in the presence of \mathbf{B} and \mathbf{E} which are perpendicular to each other

6.1 General case

$$\mathbf{F} = q(\mathbf{E} + \mathbf{v} \times \mathbf{B})$$

Lorentz force in the presence of both \mathbf{E} and \mathbf{B}

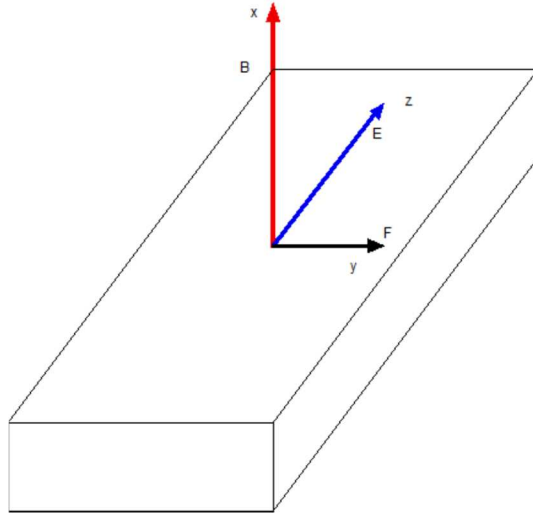

The equation of motion for the particle with charge q and mass m , is given by

$$\mathbf{F} = m\dot{\mathbf{r}} = q(\dot{\mathbf{r}} \times \mathbf{B}) + q\mathbf{E}$$

Here $\mathbf{B} = (B, 0, 0)$ and $\mathbf{E} = (0, 0, E)$.

$$\dot{\mathbf{r}} \times \mathbf{B} = \begin{vmatrix} \hat{x} & \hat{y} & \hat{z} \\ \dot{x} & \dot{y} & \dot{z} \\ B & 0 & 0 \end{vmatrix} = (0, B\dot{z}, -B\dot{y})$$

$$m\ddot{x} = 0$$

$$m\ddot{y} = qB\dot{z}, \quad \text{or}$$

$$m\ddot{z} = -qB\dot{y} + qE$$

$$\ddot{x} = 0$$

$$\ddot{y} = \frac{qB}{m}\dot{z} = \omega_c\dot{z}$$

$$\ddot{z} = -\frac{qB}{m}\dot{y} + \frac{qE}{m} = -\omega_c\left(\dot{y} - \frac{E}{B}\right)$$

where $\omega_c = \frac{qB}{m}$

6.2 Drift velocity

The particle moves in the y direction with a constant velocity (*drift velocity*).

$$\dot{y} = \frac{E}{B}, \quad \ddot{y} = 0$$

where

$$\ddot{x} = 0$$

$$\ddot{z} = \dot{z} = 0$$

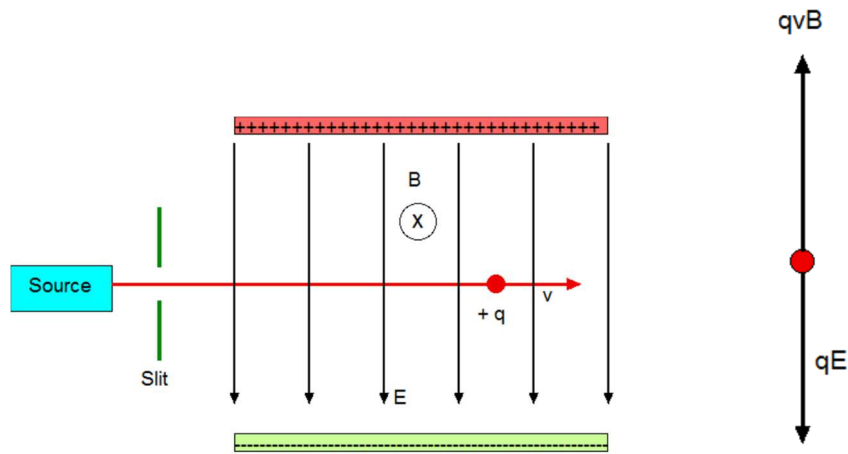

When the force due to the electric field E is equal but opposite to the force due to the magnetic field B , the particle moves in a straight line; $v = E/B$.

Velocity selector:

Only those particles with the given speed ($v = E/B$) will pass through the two fields undeflected. The magnetic force exerted on particles moving at speed greater than this is stronger than the electric field and the particles will be deflected upward. Those moving more slowly will be deflected downward.

6.3 Cycloid motion

We use the following initial conditions at $t = 0$,

$$\dot{x} = 0, \dot{y} = 0, \dot{z} = 0, \quad x = 0, y = 0, z = 0$$

Form the equation of motion, we have

$$\dot{x} = 0.$$

since $\ddot{x} = 0$. The time dependence of y and z can be solved by using Mathematica. It follows that the motion shows a cycloid motion.

$$y(t) = \frac{E}{\omega B} [\omega t - \sin(\omega t)]$$

$$z(t) = \frac{E}{\omega B} [1 - \cos(\omega t)]$$

(cycloid)

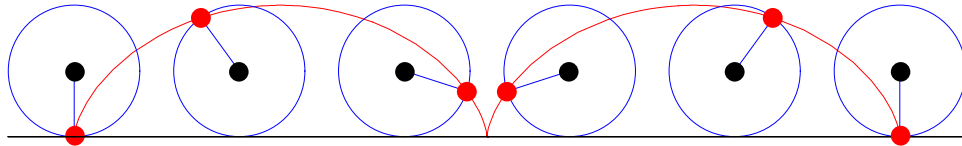

((Mathematica))

```

eq1 = {y''[t] == ω z'[t], z''[t] == -ω (y'[t] -  $\frac{E1}{B}$ )},
      y[0] == 0, y'[0] == 0, z'[0] == 0, z[0] == 0};
eq2 = DSolve[eq1, {y[t], z[t]}, t] // Simplify
{{y[t] ->  $\frac{E1 (t \omega - \text{Sin}[t \omega])}{B \omega}$ , z[t] ->  $\frac{E1 - E1 \text{Cos}[t \omega]}{B \omega}$ }}
rule1 = {E1 -> 1, ω -> 1, B -> 1};
y1[t_] = y[t] /. eq2[[1]] /. rule1;
z1[t_] = z[t] /. eq2[[1]] /. rule1; eq3 = {y1[t], z1[t]};
ParametricPlot[eq3, {t, 0, 4 π},
  PlotStyle -> {Red, Thick},
  AxesLabel -> {"y/(E/ωB)", "z/(E/ωB)"}]

```

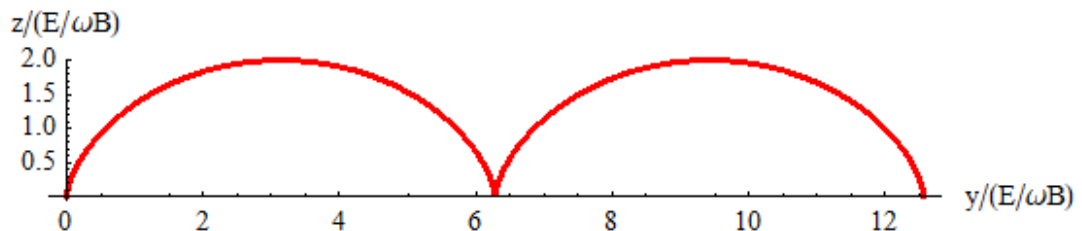

7. Hall effect

The standard geometry for the Hall effect, rod-shaped specimen of rectangular cross-section is placed in a magnetic field \mathbf{B} ($\parallel z$). An electric field \mathbf{E} ($\parallel x$), applied across the end electrodes causes an electric current density J_x , to flow down the rod. The drift velocity, of the negatively charges electrons immediately after the electric field is applied. The deflection in the y direction is caused by the magnetic field. Electrons accumulate on one face of the rod and a positive ion excess is established on the opposite face until the transverse electric field (Hall field) just cancels the Lorentz force due to the magnetic field.

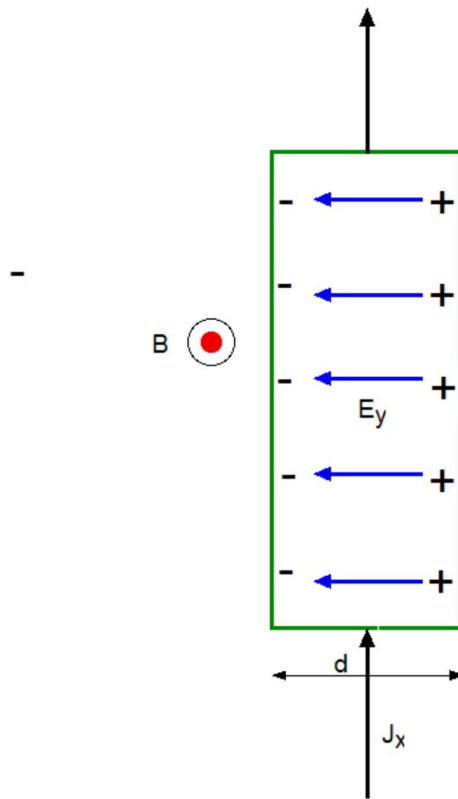
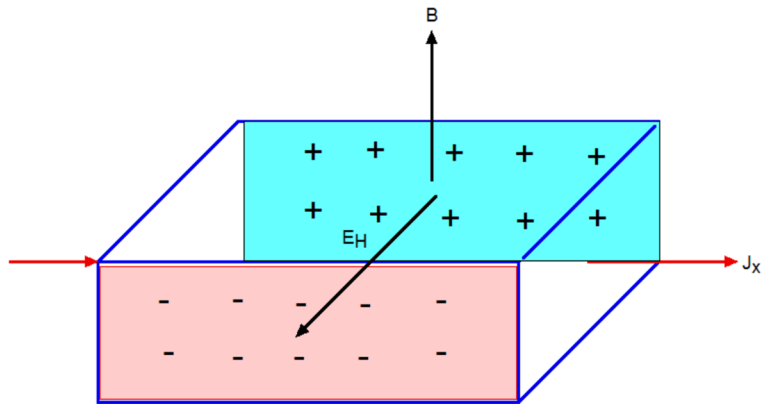
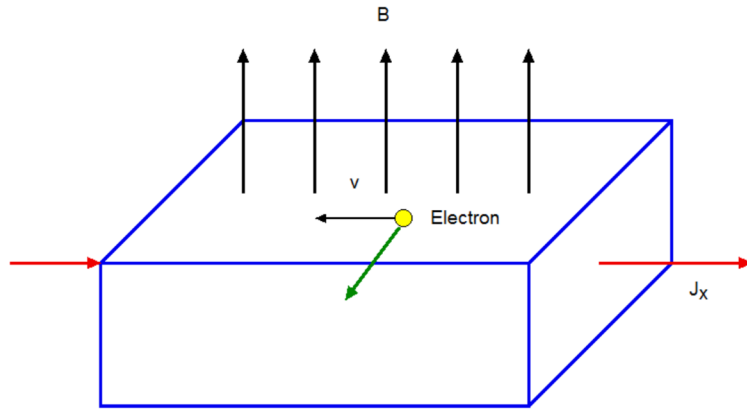

Consider a rectangular rod carrying an electric current. The rod is immersed in a uniform magnetic field B perpendicular to the current. The magnetic force qvB diverts the moving charges within the rod to one side. Since the current is confined to the rod, the diverted charges built up at one side and are depleted from the other side until such charges produce a transverse electric force that exactly balances the magnetic force. If we let denote the corresponding electric field, in the direction perpendicular to the current, equilibrium implies

$$qE_y = qvB$$

If the width of the rod is d , the transverse electric field produces a potential difference between the sides of the rod known as the Hall voltage ΔV_H , where

$$\Delta V_H = E_y d = vBd$$

The current density J_x is given by

$$J_x = nqv$$

The ratio E_y/J_x is expressed by

$$\frac{E_y}{J_x} = \frac{vB}{nqv} = \frac{B}{nq},$$

or

$$\frac{V_y}{I_x} = \frac{E_y d}{J_x A} = \frac{Bd}{nq(td)} = \frac{B}{nqt}$$

where $A = td$, and t is the thickness of the rod. Note that the Hall coefficient is defined by

$$R_H = \frac{E_y}{BJ_x} = \frac{1}{nq}$$

which depend on the sign of charge ($q = -e$ for the electron and $q = +e$ for hole) and the carrier density n .

((Wikipedia))

One very important feature of the Hall effect is that it differentiates between positive charges moving in one direction and negative charges moving in the opposite. The Hall effect offered the first real proof that electric currents in metals are carried by moving electrons, not by protons. The Hall effect also showed that in some substances (especially semiconductors), it is more appropriate to think of the current as positive "holes" moving rather than negative electrons.

Quantum Hall effect
Hall probe (magnetic field sensor)

8. Current and current density

$$I = \frac{dQ}{dt} \quad \text{charge per unit time (C/s)}$$

Charge q

Carrier density n

In a time interval Δt ,

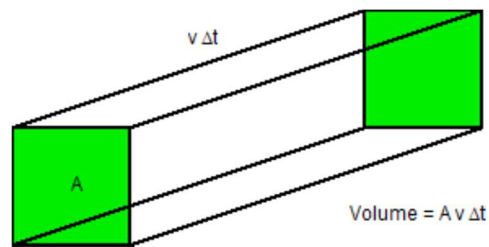

In a time interval Δt , the amount of charges passing through the area a ,

$$\text{volume} = A v \Delta t$$

$$\text{total charge} = \Delta Q = qn(Av\Delta t)$$

The total current

$$I = \frac{\Delta Q}{\Delta t} = qnvA$$

The current density (or volume current density) is defined by

$$\mathbf{J} = \frac{\mathbf{I}}{A} = qn\mathbf{v} = \rho\mathbf{v} \quad (\text{A/m}^2)$$

where ρ is the charge density.

9 The magnetic force on a current

$$\mathbf{f} = q\mathbf{v} \times \mathbf{B} \quad \text{per particle}$$

$$\Delta\mathbf{F} = n\mathbf{f} = nq\mathbf{v} \times \mathbf{B} \quad \text{per unit volume}$$

where n is the carrier number per unit volume. Since $\mathbf{J} = nq\mathbf{v} = \rho\mathbf{v}$, we have

$$\Delta\mathbf{F} = \mathbf{J} \times \mathbf{B} \quad \text{per unit volume}$$

where $\rho = nq$ is the volume charge density. The total force \mathbf{F} is given by

$$\mathbf{F} = \int d^3\mathbf{r}(\mathbf{J} \times \mathbf{B})$$

where $d^3\mathbf{r} = dV$ is the volume element.

We now consider the system of cylinder with length dL and the circular area A . The volume $d\tau$ is equal to $d^3\mathbf{r} = Adl$.

$$d\mathbf{F} = (AdL)(\mathbf{J} \times \mathbf{B}) = dL(A\mathbf{J} \times \mathbf{B}) = dL(\mathbf{I} \times \mathbf{B}) = I(d\mathbf{L} \times \mathbf{B})$$

or

$$d\mathbf{F} = I(d\mathbf{L} \times \mathbf{B})$$

since $I d\mathbf{L} = IdL$. The direction of \mathbf{I} is the same as that of $d\mathbf{L}$. This formula is basic for calculating the magnetic force on a wire that carries a current.

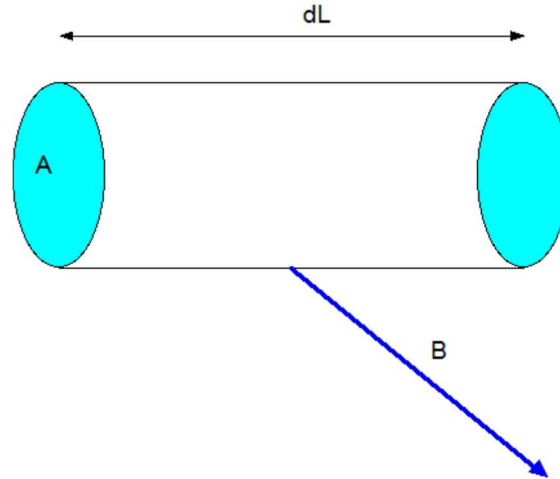

If the wire is straight and in a uniform field \mathbf{B} , we have

$$\mathbf{F} = L(\mathbf{I} \times \mathbf{B})$$

The magnitude of \mathbf{F} is

$$F = LIB \sin \theta.$$

where q is the angle between vectors I and B . The direction of F is perpendicular to the plane made by vectors B and I , following the right-hand rule.

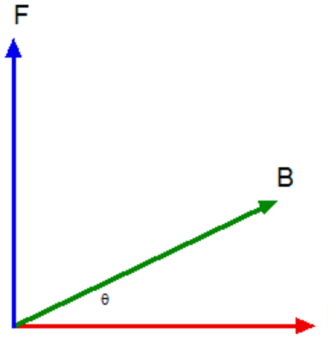

((Note)) The method used by Walter Lewin

$$F = (\Delta Q)[v \times B]$$

or

$$F = \left(\frac{\Delta Q}{\Delta t}\right)[v(\Delta t) \times B] = I(I \times B) = l(I \times B)$$

((Example))

A semi-circular loop of radius r carries current I . A uniform magnetic field B is present perpendicular to the plane of the circle. What is the force exerted on the wire?

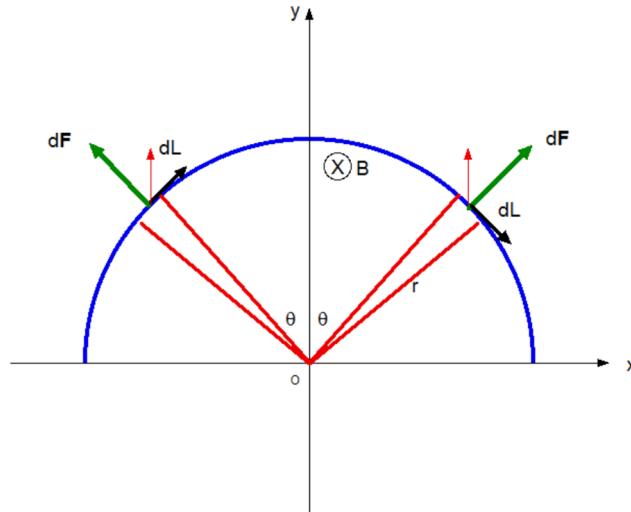

A circular loop of radius r wire carries constant current I . A uniform magnetic field B is applied into the page. We calculate the force applied on the current

From the symmetry, the x component of the force is zero. The y component of the force is given by

$$F_y = \int_0^{\pi/2} 2IB \cos \theta dL = \int_0^{\pi/2} 2IBr \cos \theta d\theta = 2IBr$$

where we consider the contribution of the force from the current elements $(\theta - \theta + d\theta)$ (in pair) in both sides symmetric with the y axis.

10. Torque on a current loop in a uniform magnetic field

10.1 Concept of the magnetic dipole moment (or magnetic moment)

We consider a rectangular loop of wire which is carrying a current I in a counterclockwise. The magnetic field \mathbf{B} lies in the plane of the loop. The length of the loop is b and its width is a . We now calculate the net force on the loop carrying the current due to the presence of \mathbf{B} .

(a) $\mathbf{B} // x$

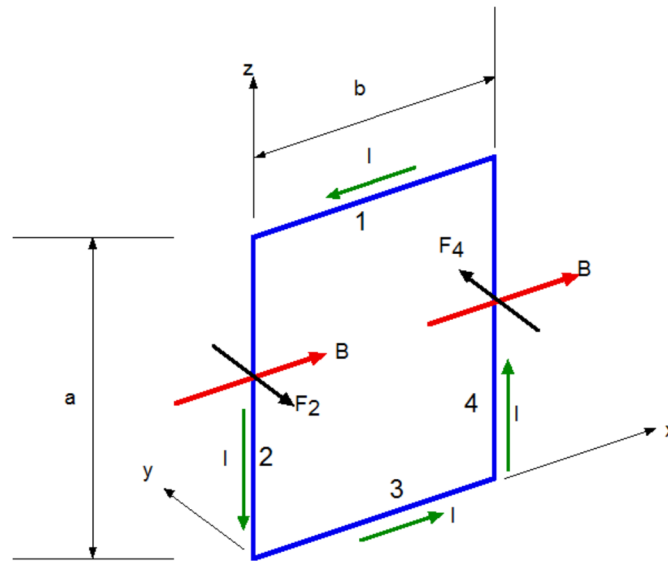

No magnetic force acts on the sides 1 and 3 since the wires are parallel to \mathbf{B} . Magnetic forces act on the sides 2 and 4;

$$F_2 = F_4 = aIB$$

since these sides are perpendicular to \mathbf{B} . The direction of \mathbf{F}_2 is in the negative y axis, while the direction of \mathbf{F}_4 is in the positive y axis. Next figure shows the top view of the system.

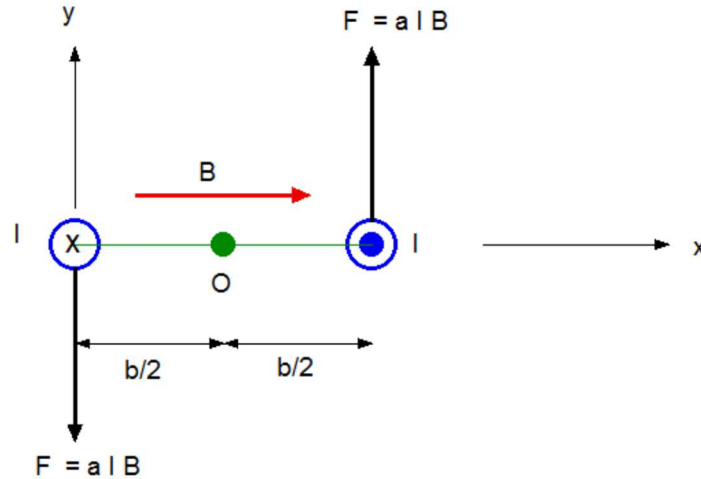

Fig. The direction of the torque vector is in the positive z direction (out of page). The current on the side 2 flows into the page, while the current on the side 4 flows out of page.

The forces are equal and in opposite directions, but not along the same line of action. The forces produce a torque around the point O . The magnitude of the net torque is given by

$$\tau = F \frac{b}{2} + F \frac{b}{2} = IabB = IAB$$

The counter-clock wise direction of torque implies that the direction of the torque vector τ is along the positive z direction.

Here we define the magnetic dipole moment (magnetic moment) μ of the current loop to be a vector directed along the direction perpendicular to the current loop and to have the magnitude of IA ;

$$\mu = Iab = IA = (\text{current}) \times (\text{area}).$$

The direction of the magnetic moment follows the right-hand rule. In the present case, the direction of the magnetic moment is the negative y direction. Then the magnitude of τ is expressed by

$$\tau = \mu B$$

(b) The magnetic field in the xy plane

Next we assume that the magnetic field B makes an angle of $\phi (< \pi/2)$ with the x axis. The magnetic field B is in the x - y plane. The forces on the sides 1 and 3 are no longer equal to zero because of the y component of the magnetic field B .

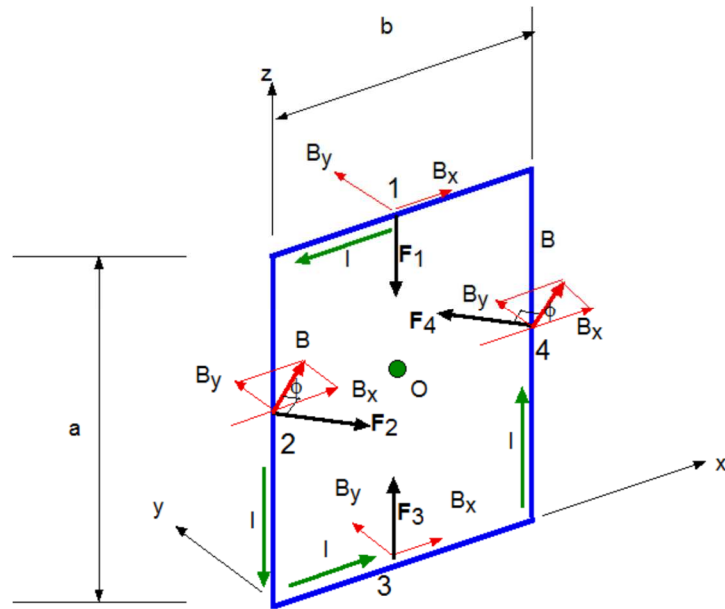

The net torque around the point O is

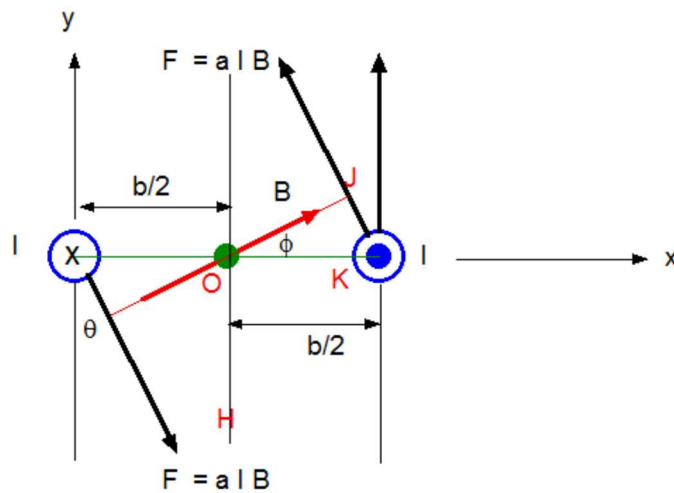

Top view

Fig. $\angle JOK = \phi$ and $\angle JOH = \theta = \phi + \pi/2$. The magnetic moment is directed along the negative y axis. The direction of the torque vector τ is along the positive z axis.

The forces on the sides 1 and 3 are no longer equal to zero: The force on the side 1 (F_1) is equal and opposite to the force on the side 3 (F_3): $F_1 = F_3 = IbB_y$. The direction of F_1 is in the negative z direction, while the direction of F_3 is the positive z direction. Since the arm's length for F_1 and F_3 is equal to zero, there is no contribution of these forces to the net torque. Then the torque around the origin is

$$\begin{aligned}\tau &= F \frac{b}{2} \cos \phi + F \frac{b}{2} \cos \phi \\ &= Fb \cos \phi = abIB \cos(\theta - \frac{\pi}{2}) = \mu B \sin \theta\end{aligned}$$

where $\angle JOK = \phi$, $\angle JOH = \theta = \phi + \pi/2$, and $F = aIB$. The counter-clock wise direction of the net torque implies that the direction of the torque vector $\boldsymbol{\tau}$ is along the positive z axis.

$$\boldsymbol{\tau} = \boldsymbol{\mu} \times \mathbf{B}$$

where A is the area of current loop, I is the current.

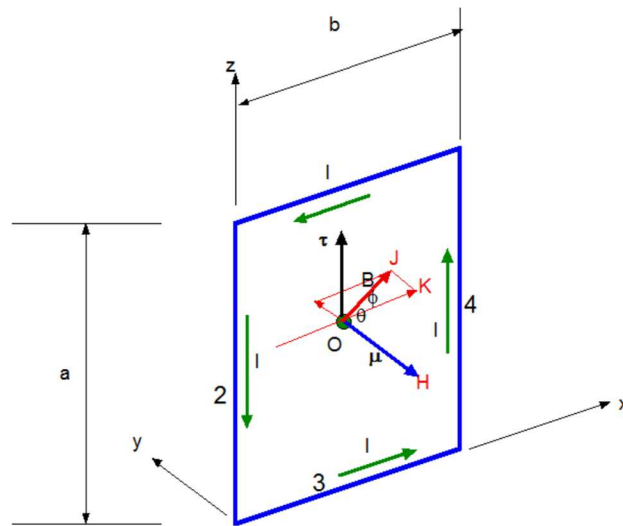

This formula is analogous to the formula for the torque acting on an electric dipole \mathbf{p} in an electric field \mathbf{E} ,

$$\boldsymbol{\tau} = \mathbf{p} \times \mathbf{E}$$

10.2 Unit of the magnetic dipole moment (magnetic moment)

In general, the magnetic moment of a current loop of any shape is defined as

$$\boldsymbol{\mu} = IA$$

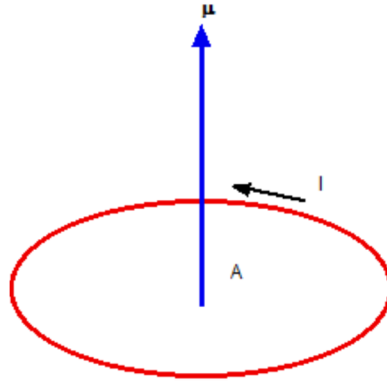

where A is the area enclosed by the loop and I the current. The direction of the magnetic moment is perpendicular to the plane of the current loop, following the right-hand rule.

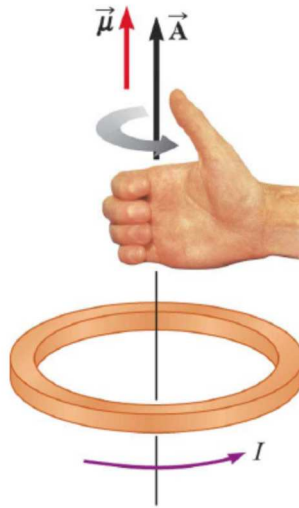

Figure The right-hand rule for the magnetic moment

The unit of the magnetic moment is as follows.

$$[\mu] = A \cdot m^2 = J/T$$

$$J = N \cdot m = C \cdot (m/s) \cdot T \cdot m = A \cdot m^2 \cdot T$$

where

$$\begin{array}{ll} N = C \cdot (m/s) \cdot T & \text{from the formula } \mathbf{F} = q \cdot (\mathbf{v} \times \mathbf{B}) \\ A = C/s & \text{from the formula } I = dQ/dt \end{array}$$

10.3 Examples of the magnetic moments

The magnetic moments:

Earth	$8.017 \times 10^{22} \text{ A m}^2$
Jupiter	$1.4 \times 10^{27} \text{ A m}^2$

Electronic Bohr magneton

$$9.28476377 \times 10^{-24} \text{ A m}^2$$

Suppose that the equivalent current I_E flows at the equator of the Earth, giving rise to the magnetic moment of the Earth. Then we have

$$I_E = \frac{\mu_E}{\pi R_E^2} = 6.29 \times 10^8 \text{ A},$$

where $\mu_E (= 8.017 \times 10^{22} \text{ A m}^2)$ is the magnetic moment of the Earth and $R_E (= 6.372 \times 10^6 \text{ m})$ is the radius of the Earth. Note that the magnitude of the magnetic moment of the Earth gradually decreases with increasing time.

10.4 Simple harmonic oscillation of magnetic dipole moment with the moment of inertia (Junior Lab, BU Physic Department)

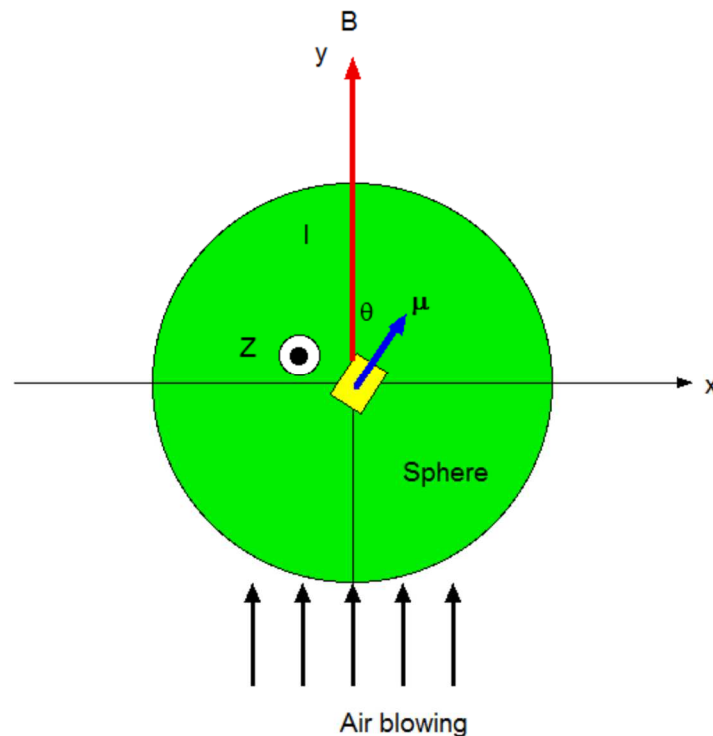

Suppose that the magnet with magnetic dipole moment μ (in the $x y$ plane) is installed in the cue ball. The magnetic field \mathbf{B} is applied along the y axis. Then the cue ball, which is supported by the air bearing, acts like a spherical physical pendulum. A magnetic dipole moment μ in the presence of \mathbf{B} along the y axis will experience the torque,

$$\tau = \mu \times \mathbf{B} = \mu B \sin \theta \mathbf{e}_z$$

where θ is the angle between μ and \mathbf{B} . If the cue ball is free to rotate, its response to the torque τ will be a change in its angular momentum at the rate $d\mathbf{L}/dt$;

$$\frac{d\mathbf{L}}{dt} = \boldsymbol{\tau}$$

Here we note that

$$\frac{d\mathbf{L}}{dt} = I\ddot{\theta}(-\mathbf{e}_z)$$

Here I is the moment of inertia of the dipole about the z axis, and I is given by

$$I = \frac{2}{5}MR^2$$

where M is the mass of cue ball and R is the radius of sphere. Then we find that the cue ball undergoes a simple harmonic oscillation in the limit of small θ .

$$I\ddot{\theta} = -\mu B \sin \theta \approx -\mu B \theta$$
$$\ddot{\theta} = -\frac{\mu B}{I} \theta = -\omega^2 \theta$$

Here ω is the angular frequency given by

$$\omega = \sqrt{\frac{\mu B}{I}}$$

The period T is obtained as

$$T = \frac{2\pi}{\omega} = 2\pi \sqrt{\frac{I}{\mu B}}$$

((**Note**)) In the Junior laboratory (Phys.327), we use the Magnetic Torque (Teachspin),

11. Potential energy

11.1 Definition

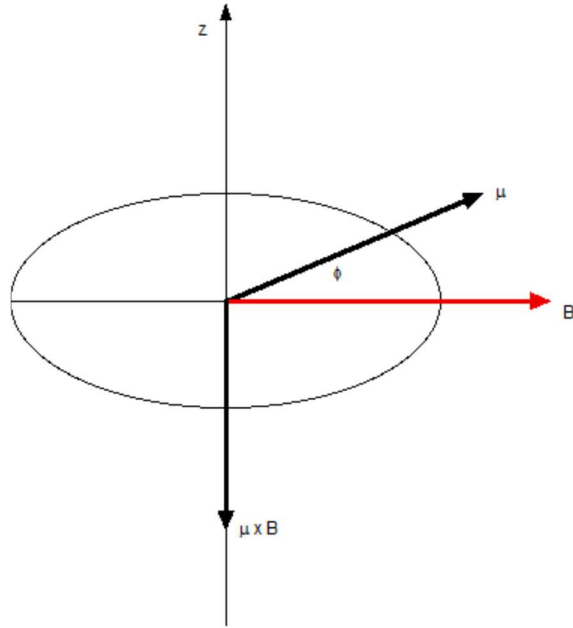

$$W = -\int \tau d\varphi = -\mu B \int_0^\theta \sin \varphi d\varphi = \mu B \cos \theta = \boldsymbol{\mu} \cdot \mathbf{B}$$

The negative sign arises from the direction of the torque. Note that $(-\tau)$ is the torque in the counter-clockwise (+z axis). Since $\Delta U = -\Delta W$, we have the expression of the potential energy,

$$U = -\boldsymbol{\mu} \cdot \mathbf{B}.$$

The potential energy is minimum when $\boldsymbol{\mu}$ and \mathbf{B} are parallel. The potential energy is maximum when $\boldsymbol{\mu}$ and \mathbf{B} are antiparallel. The potential energy is called a Zeeman energy.

$$U = \varepsilon(\theta) = -\mu B \cos \theta$$

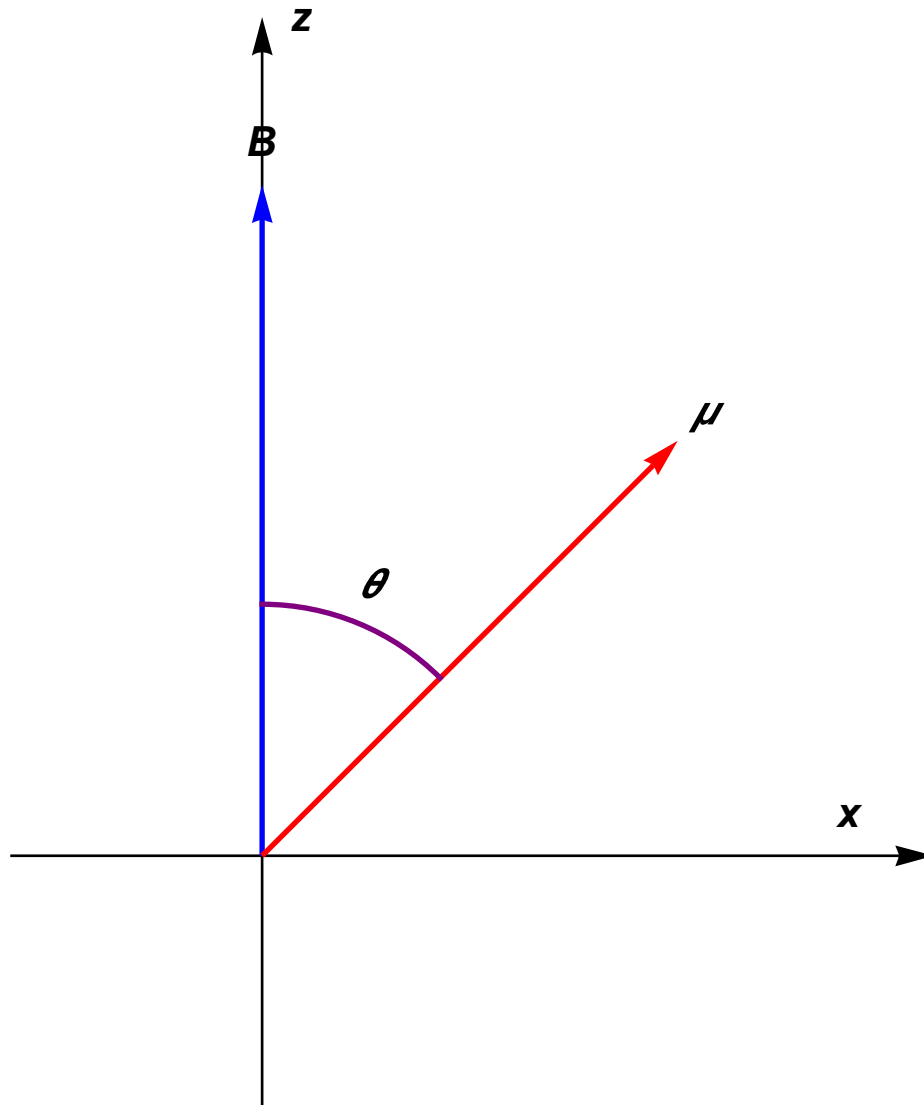

We make a plot of $U = \varepsilon(\theta) = -\mu B \cos \theta$ as a function of θ (the angle between B and the magnetic dipole moment μ).

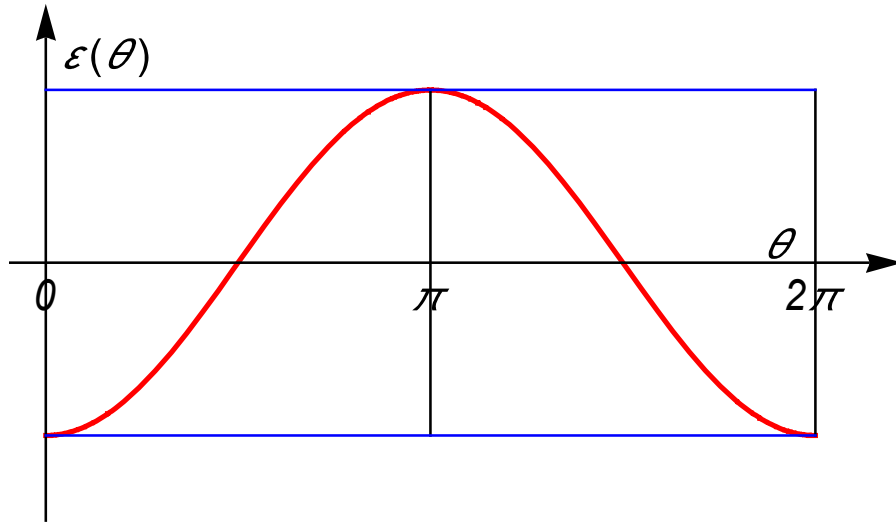

Fig. $U = \varepsilon(\theta) = -\mu B \cos \theta$. U has a minimum at $\theta = 0$ (parallel), while it has a maximum at $\theta = \pi$ (antiparallel),

11.2 Force: Stern-Gerlach experiment

The force exerted on the magnetic moment $\boldsymbol{\mu}$ due to the inhomogeneous external force \mathbf{B} (dependent on \mathbf{r}) is given by

$$\mathbf{F} = -\nabla U = \nabla[\boldsymbol{\mu} \cdot \mathbf{B}(\mathbf{r})].$$

When $\mathbf{B}(\mathbf{r}) = B_z(z)\mathbf{e}_z$ (the magnetic is applied along the z axis) and B_z depends on z , the force along the z direction is given by

$$F_z = \mu_z \frac{\partial B_z}{\partial z}$$

An important experiment performed by Stern and Gerlach in 1921 demonstrated the fact that individual atoms possess magnetic moments. In their experiment, Stern and Gerlach heated silver (Ag) in an oven until it vaporized. A beam of silver atoms passes through an inhomogeneous magnetic field and were ultimately detected by a photographic plate. They found that the beam of Ag atoms was indeed deviated by the magnetic field, but that instead of a broadened trace on the plane, the beam had split up into two parts. One of the parts corresponded to the alignment of \mathbf{m} in the positive z direction, the other to its anti-alignment. This phenomenon, called *space quantization*, is one of the most significant in atomic physics.

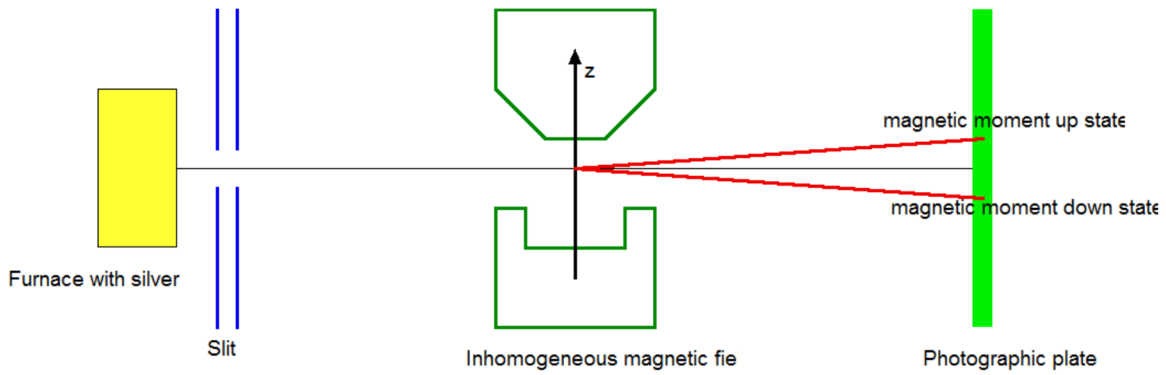

12. Orbital magnetic moment

We consider an electron which undergoes an orbital motion [radius r , mass m , and charge $(-e)$; $e > 0$].

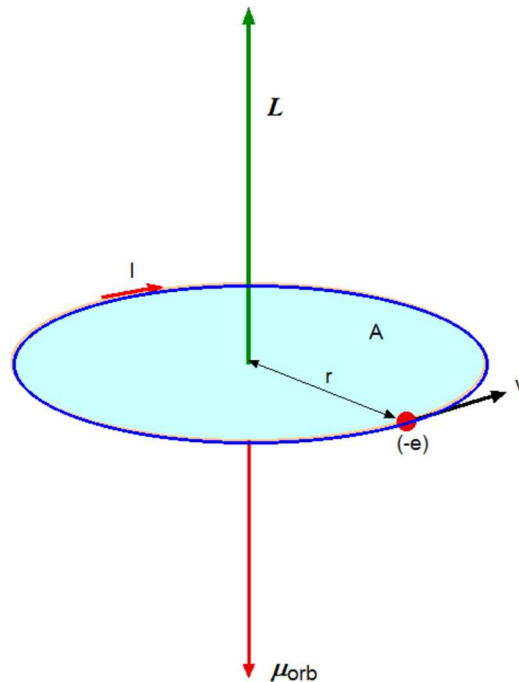

From the definition, the magnetic moment μ_{orb} due to the orbital motion is given by

$$\mu_{orb} = IA$$

where A is the area, $A = \pi r^2$. I is the current and is given by $I = \frac{e}{T} = \frac{e}{(2\pi r/v)} = \frac{ev}{2\pi r}$. The

Note that the direction of the current is opposite to the direction of velocity of electron because the charge is negative.

$$\mu_{orb} = \frac{ev}{2\pi r} \pi r^2 = \frac{evr}{2} = \frac{emvr}{2m} = \frac{e}{2m} L_z = \frac{e\hbar}{2m} \frac{L_z}{\hbar}$$

where $L_z (= mvr)$ is the z component of the orbital angular momentum. The Bohr magneton μ_B is defined as

$$\mu_B = \frac{e\hbar}{2m} = 9.27400915 \times 10^{-24} \text{ Am}^2 \text{ [(=J/T), SI units]}$$

In a vector form, we have the orbital magnetic moment is related to the orbital angular momentum,

$$\boldsymbol{\mu}_{orb} = -\frac{e}{2m} \mathbf{L} = -\frac{e\hbar}{2m} \frac{\mathbf{L}}{\hbar} = -\mu_B \frac{\mathbf{L}}{\hbar}$$

((Note)) The Bohr magneton μ_B in the units of c.g.s. is expressed by

$$\mu_B = \frac{e\hbar}{2mc} = 9.27400915 \times 10^{-21} \text{ emu [= erg/G]}$$

$$1 \text{ emu} = 1 \text{ erg/G} = 10^{-7} \text{ J}/10^{-4}\text{T} = 10^{-3} \text{ J/T}$$

((Note))

Gyromagnetic ratio γ

In general the magnetic moment $\boldsymbol{\mu}$ is related to its angular momentum \mathbf{L} through a gyromagnetic ratio γ as

$$\boldsymbol{\mu} = \gamma \mathbf{L}$$

13. Magnetic moment of the rotating disk

We consider the case when charge Q is uniformly distributed on the disk. Suppose that the disk is rotated at the angular frequency (ω) around the center. What is the magnetic moment?

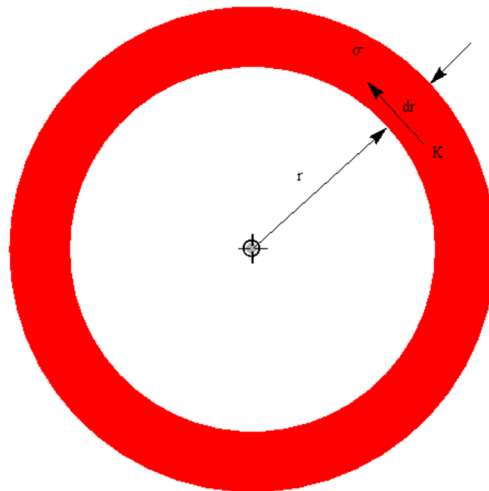

The total charge (ΔQ) in the region between r and $r + dr$,

$$\Delta Q = 2\pi r dr \sigma$$

When the disk rotates around the center axis with the angular velocity ω , the current arising from the charge ΔQ ,

$$\Delta I = K dr = \Delta Q \frac{\omega}{2\pi} = 2\pi r dr \sigma \frac{\omega}{2\pi} = \sigma \omega r dr$$

The surface current density K is given by $K = \sigma \omega r$. The magnetic moment of the rotating disk (radius R)

$$d\mu = \pi r^2 \Delta I = \pi r^2 \sigma \omega r dr = \pi r^3 \sigma \omega dr$$

$$\mu = \int_0^R \pi r^3 \sigma \omega dr = \frac{\pi \sigma \omega R^4}{4}$$

Since $Q = \pi R^2 \sigma$, μ can be rewritten as

$$\mu = \frac{\pi \omega R^4}{4} \frac{Q}{\pi R^2} = \frac{1}{4} Q \omega R^2$$

14. Magnetic moment of the rotating spherical shell

We consider the case when charge Q is uniformly distributed on the surface of the sphere. Suppose that the sphere is rotated at the angular frequency (ω) around the axis passing through the center of the sphere. What is the magnetic moment?

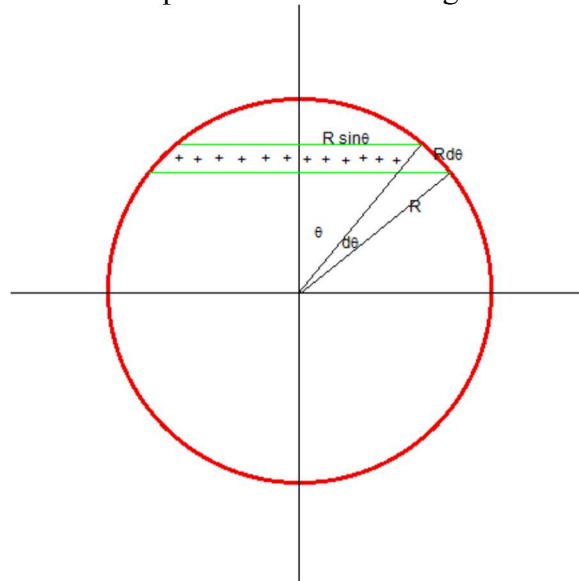

The charge inside the spherical shell between θ and $\theta + d\theta$,

$$\Delta Q = \sigma(2\pi R \sin \theta) R d\theta$$

The magnetic moment from this part rotating around the rotation axis (the z axis) at the angular frequency ω ,

$$\begin{aligned} \Delta \mu &= (\pi R^2 \sin^2 \theta) \left(\Delta Q \frac{\omega}{2\pi} \right) = (\pi R^2 \sin^2 \theta) \left(\frac{\omega}{2\pi} \right) \sigma (2\pi R \sin \theta) R d\theta \\ &= \pi R^4 \sigma \omega \sin^3 \theta d\theta \end{aligned}$$

or

$$\mu = \pi R^4 \sigma \omega \int_0^\pi \sin^3 \theta d\theta = \frac{4}{3} \pi R^4 \sigma \omega$$

Using the total charge $Q (= 4\pi R^2 \sigma)$ on the surface

$$\mu = \frac{\omega Q R^2}{3}$$

((Mathematica))

$$\int_0^\pi \sin[\theta]^3 d\theta$$

$$\frac{4}{3}$$

15. Typical examples

15.1 Problem 28-16 (SP-28)

Figure shows a metallic block, with its faces parallel to coordinate axes. The block is in a uniform magnetic field of magnitude 0.020 T. One edge of the block is 25 cm; the block is not drawn to scale. The block is moved at 3.0 m/s parallel to each axis, in turn, and the resulting potential difference V that appears across the block is measured. With the motion parallel to the y axis, $V = 12$ mV; with the motion parallel to the z axis, $V = 18$ mV; with the motion parallel to the x axis, $V = 0$. What are the block lengths (a) dx , (b) dy , and (c) dz ?

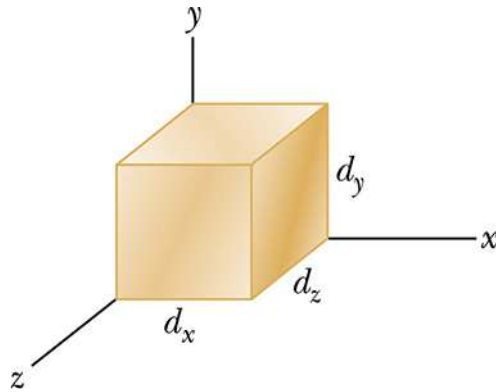

((My solution))

$\mathbf{B} // x$

$d_x = 25 \text{ cm}$

$B = 0.020 \text{ T}$

$v = 3.0 \text{ m/s}$

For $\mathbf{v} // x$, there is no force on charged particles because of $\mathbf{v} \times \mathbf{B} = 0$. This leads to no voltage.

For $\mathbf{v} // y$, the voltage is generated along the z axis.

$$V_z = -vBd_z$$

or

$$vBd_z = 12 \text{ mV} \quad d_z = \frac{12 \times 10^{-3}}{0.020 \times 3} = 20 \text{ cm}$$

For $\mathbf{v} // z$, the voltage is generated along the y axis,

$$V_y = vBd_y = 18 \text{ mV} \quad d_y = \frac{18 \times 10^{-3}}{0.020 \times 3} = 30 \text{ cm}$$

(a) $d_x = 25 \text{ cm}$

(b) $d_y = 30 \text{ cm}$

(c) $d_z = 20 \text{ cm}$

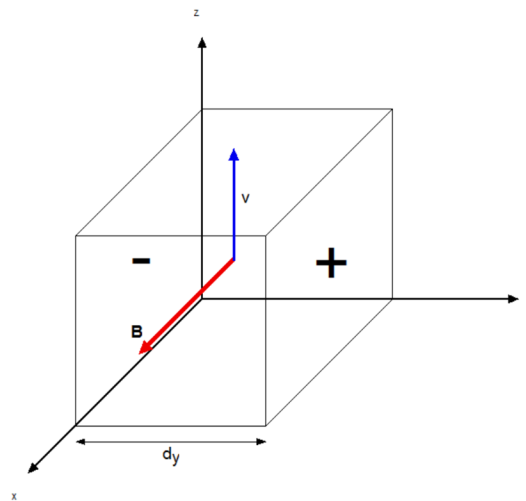
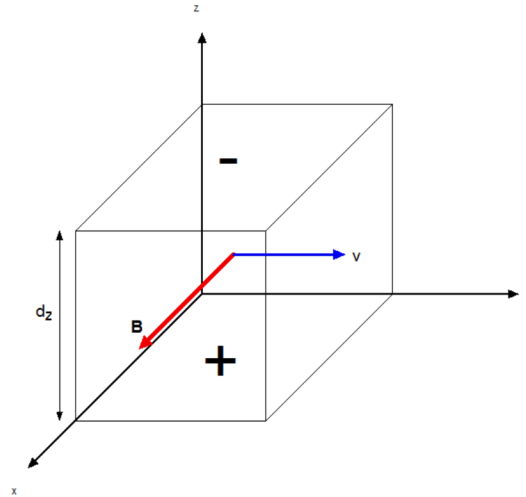

15.2 Problem 28-27 (SP-28)

An electron follows a helical path in a uniform magnetic field of magnitude 0.300 T. The pitch of the path is $6.00 \mu\text{m}$, and the magnitude of the magnetic force on the electron is $2.00 \times 10^{-15} \text{ N}$. What is the electron's speed?

((Solution))

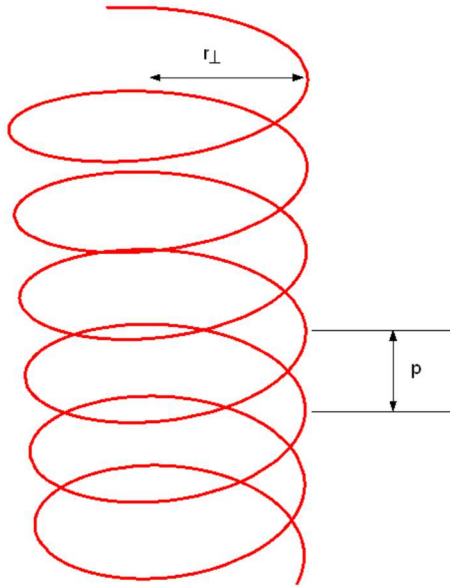

Helical path

$$B = 0.3 \text{ T}$$

$$p = 6.00 \text{ } \mu\text{m (pitch)}$$

$$F = 2.00 \times 10^{-15} \text{ N}$$

$$T = \frac{2\pi r}{v} = \frac{p}{v_{\parallel}}$$

where v is the in-plane velocity and v_{\parallel} is the velocity along the spiral axis.

$$F = qvB = m \frac{v^2}{r}$$

$$mv = qBr$$

Then we have

$$T = \frac{2\pi r}{v} = 2\pi \frac{m}{qB}$$

The in-plane velocity v is

$$v = \frac{F}{qB} = 41.61 \text{ km/s}$$

The velocity along the spiral axis $v_{//}$ is

$$v_{//} = \frac{p}{T} = \frac{pqB}{2\pi m} = 50.386 \text{ km/s}$$

The resultant velocity is

$$\sqrt{v^2 + v_{//}^2} = 65.347 \text{ km/s}$$

15.3 Problem 28-45 (SP-28)

A 1.0 kg copper rod rests on two horizontal rails 1.0 m apart and carries a current of 50 A from one rail to the other. The coefficient of static friction between rod and rails is 0.60. What are the (a) magnitude and (b) angle (relative to the vertical) of the smallest magnetic field that puts the rod on the verge of sliding?

((Solution))

$$m = 1.0 \text{ kg}$$

$$d = 1.0 \text{ m}$$

$$\mu_s = 0.60$$

$$i = 50 \text{ A}$$

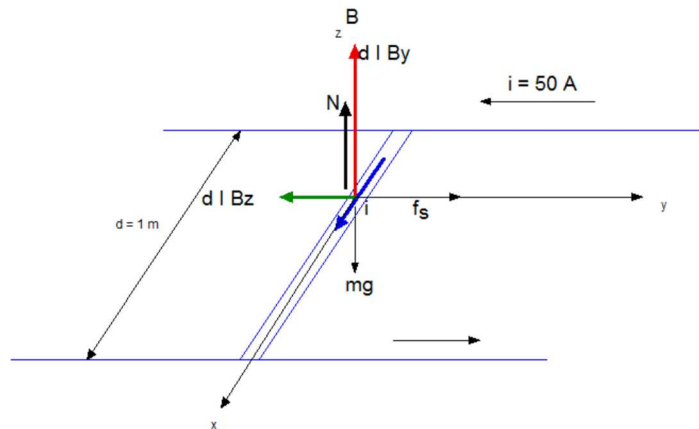

The force F is given by

$$\mathbf{F} = d(\mathbf{I} \times \mathbf{B}) = d \begin{vmatrix} \mathbf{e}_x & \mathbf{e}_y & \mathbf{e}_z \\ I & 0 & 0 \\ B_x & B_y & B_z \end{vmatrix} = dI(0, -B_z, B_y)$$

Equation of motion

$$\begin{aligned}
 dIB_z - f_s &= 0 \\
 N + dIB_y - mg &= 0 \\
 f_s &\leq \mu_s N
 \end{aligned}$$

or

$$dIB_z \leq \mu_s (mg - dIB_y)$$

B_x is independent of this inequality, We assume that $B_x = 0$.

$$B_z = B \cos \theta \quad B_y = B \sin \theta$$

$$dIB \cos \theta \leq \mu_s (mg - dIB \sin \theta)$$

$$B \leq \frac{\mu_s mg}{dI[\cos \theta + \mu_s \sin \theta]} = \frac{\mu_s mg}{dI\sqrt{\mu_s^2 + 1}} \frac{1}{\sin(\theta + \phi)}$$

with

$$\tan \phi = \frac{1}{\mu_s} = \frac{1}{0.6} = 1.66667$$

$$\phi = 59.04^\circ$$

When , $\theta + \phi = 90^\circ$ or $\theta = 30.96^\circ$, the smallest magnetic field is

$$B = \frac{\mu_s mg}{dI\sqrt{\mu_s^2 + 1}} = 0.10T$$

15.4 Problem28-53 (SP-28)

Figure shows a wood cylinder of mass $m = 0.250$ kg and length $L = 0.100$ m, with $N = 10.0$ turns of wire wrapped around it longitudinally, so that the plane of the wire coil contains the long central axis of the cylinder. The cylinder is released on a plane inclined at an angle θ to the horizontal, with the plane of the coil parallel to the incline plane. If there is a vertical uniform magnetic field of magnitude 0.500 T, what is the least current i through the coil that keeps the cylinder from rolling down the plane?

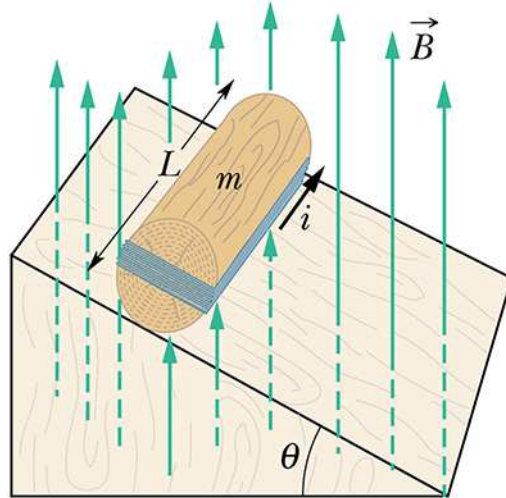

((Solution))

$$B = 0.500 \text{ T}$$

$$m = 0.25 \text{ kg}$$

$$L = 0.10 \text{ m}$$

$$N = 10$$

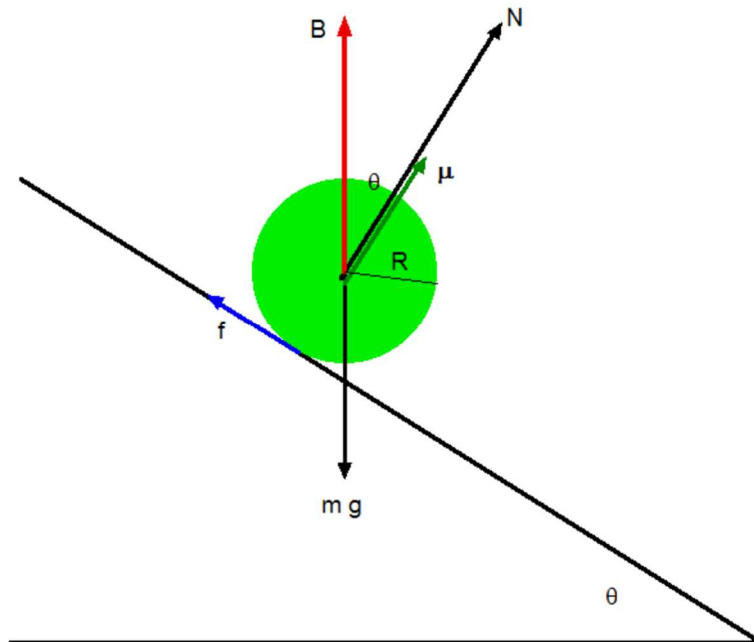

The magnetic moment is given by

$$\mu = Ni(2R)L$$

Equation of motion:

$$\begin{aligned}
 mg \sin \theta - f &= ma \\
 \tau = I\alpha &= fR - \mu B \sin \theta \\
 a &= R\alpha
 \end{aligned}$$

or

$$a = \frac{(mgR - \mu B)R}{I + mR^2} \sin \theta$$

When $a = 0$,

$$mgR = \mu B = Ni(2R)LB$$

or

$$i = \frac{mgR}{N(2R)LB} = \frac{mg}{2NLB} = 2.45 A$$

APPENDIX

A. Synchrotron

A.1 Lorentz force in the relativistic mechanics

We notice that

$$\mathbf{F} = \frac{d\mathbf{p}}{dt} = q[\mathbf{E} + (\mathbf{v} \times \mathbf{B})]$$

holds in an arbitrary frame S (see Chapters 37 and 37S). This expression is the correct relativistic form for Newton's second law. The momentum form is more fundamental. The momentum \mathbf{p} and the energy E are given by

$$\mathbf{p} = m \frac{\mathbf{v}}{\sqrt{1 - \frac{v^2}{c^2}}} = \frac{E}{c^2} \mathbf{v}$$

$$E = \frac{mc^2}{\sqrt{1 - \frac{v^2}{c^2}}} = c(m^2c^2 + \mathbf{p}^2)^{1/2}$$

where

$$\frac{E^2}{c^2} = \frac{m^2 c^2}{1 - \frac{v^2}{c^2}} = \frac{m^2 c^2 (1 - \frac{v^2}{c^2}) + m^2 v^2}{1 - \frac{v^2}{c^2}} = m^2 c^2 + \mathbf{p}^2$$

Then we get the equation of motion as

$$\frac{dE}{dt} = \frac{c^2 \mathbf{p}}{E} \cdot \frac{d\mathbf{p}}{dt} = \mathbf{v} \cdot \mathbf{F} = q(\mathbf{v} \cdot \mathbf{E})$$

((Note))

$$E = c(m^2 c^2 + \mathbf{p}^2)^{1/2}$$

$$\frac{dE}{dt} = \frac{c}{2\sqrt{m^2 c^2 + \mathbf{p}^2}} 2\mathbf{p} \cdot \frac{d\mathbf{p}}{dt} = \frac{c^2}{E} \mathbf{p} \cdot \frac{d\mathbf{p}}{dt}$$

K is the kinetic energy:

$$\begin{aligned} K &= E - mc^2 \\ &= \frac{mc^2}{\sqrt{1 - \frac{v^2}{c^2}}} - mc^2 \\ &= mc^2 \left(1 - \frac{v^2}{c^2}\right)^{-1/2} - mc^2 \\ &\approx \frac{1}{2}mv^2 \end{aligned}$$

A.2 Cyclotron motion: a particle in a uniform magnetic field along the z axis.

We now consider the case of $\mathbf{E} = 0$ (no electric field)

$$\frac{dE}{dt} = q(\mathbf{v} \cdot \mathbf{E}) = 0$$

Thus we have $\gamma(\mathbf{v}) = \frac{1}{\sqrt{1 - \frac{v^2}{c^2}}} = \frac{E}{mc^2} = \text{constant}$ (time independent)

This means that \mathbf{p} is just proportional to \mathbf{v} since

$$\mathbf{p} = \frac{E}{c^2} \mathbf{v}.$$

The equation of motion can be rewritten as

$$\frac{d}{dt} \mathbf{v} = \frac{c^2}{E} q(\mathbf{v} \times \mathbf{B})$$

or

$$\dot{v}_x = \frac{c^2 q B}{E} v_y$$

$$\dot{v}_y = -\frac{c^2 q B}{E} v_x$$

$$\dot{v}_z = 0$$

For convenience, we use the complex plane for the solution.

$$\frac{d}{dt} (v_x + i v_y) = -\frac{i c^2 q B}{E} (v_x + i v_y)$$

or

$$(v_x + i v_y) = (v_x^0 + i v_y^0) \exp\left[-\frac{i c^2 q B t}{E}\right] = v \exp[-i(\omega t + \alpha)]$$

where

$$\omega = \frac{c^2 q B}{E} = \frac{c^2 q B}{\gamma m c^2} = \frac{q B}{\gamma m},$$

and

$$v_x^0 + i v_y^0 = v e^{-i\alpha}.$$

Then we have

$$v_x = \frac{dx}{dt} = v \cos(\omega t + \alpha)$$

$$v_y = \frac{dy}{dt} = -v \sin(\omega t + \alpha)$$

or

$$v_x^2 + v_y^2 = v^2 = \text{constant}$$

$$x = \frac{v}{\omega} \sin(\omega t + \alpha) + x_1$$

$$y = \frac{v}{\omega} \cos(\omega t + \alpha) + y_1$$

This equation describes a cyclotron motion (circular motion with radius R).

$$R = \frac{v}{\omega} = \frac{vE}{c^2 q B} = \frac{v m c^2 \gamma}{c^2 q B} = \frac{m v \gamma}{q B}$$

where ω is the angular frequency,

$$\omega = \frac{c^2 q B}{E} = \frac{q B}{m \gamma}$$

The angular frequency is no longer constant but now depends on the velocity v . The resonance between the circulating frequency and the oscillation frequency no longer occurs.

As the energy of the particles (E) increase, the strength of B must be changed with each turn to keep the particles moving in the same ring. The change in B must be carefully synchronized to the change in energy, or the beam will be lost (hence the name "synchrotron"). The range of energies over which particles can be accelerated in a single ring is determined by the range of field strength available with high precision from a particular set of magnets.

((Note))

$$T = \frac{2\pi m}{q B} \gamma$$

$$R^2 = \frac{m^2 v^2 \gamma^2}{q^2 B^2} = \frac{m^2 c^2 \gamma^2}{q^2 B^2} \frac{v^2}{c^2} = \frac{m^2 c^2 \gamma^2}{q^2 B^2} \left(\frac{\gamma^2 - 1}{\gamma^2} \right)$$

or

$$R^2 = \frac{m^2 c^2}{q^2 B^2} (\gamma^2 - 1)$$

When

$$K = mc^2(\gamma - 1)$$

we have

$$R = \sqrt{\frac{mK(1 + \gamma)}{q^2 B^2}}$$

where K is the kinetic energy.

((**Mathematica**)) For electron, $K = 50 \text{ MeV}$, $B = 1 \text{ T}$
 $f = 283.2 \text{ MHz}$, $T = 3.53 \text{ ns}$, $R = 23.7 \text{ cm}$.

$$\mathbf{K1 = 50 \text{ MeV}; B1 = 1;}$$

$$\gamma = \frac{\mathbf{K1}}{\mathbf{me \text{ c}^2}} + 1 \text{ // . rule1}$$

$$98.8476$$

$$\mathbf{f1 = \frac{qe \text{ B1}}{2 \pi \text{ me } \gamma} \text{ // . rule1}}$$

$$2.83188 \times 10^8$$

$$\mathbf{R1 = \frac{\sqrt{2 \text{ K1 } \text{ me } (1 + \gamma)}}{qe \text{ B1}} \text{ // . rule1}}$$

$$0.238264$$

$$\mathbf{T1 = 1 / f1}$$

$$3.53122 \times 10^{-9}$$

B. Larmor precession for the angular momentum in the presence of magnetic field

The magnetic moment μ is related to the angular momentum as

$$\mu = \gamma L$$

We now examine the motion of the angular momentum (or magnetic moment) in the presence of the magnetic field. The torque $\boldsymbol{\tau}$ acting on the magnetic moment is

$$\boldsymbol{\tau} = \frac{d\mathbf{L}}{dt} = \boldsymbol{\mu} \times \mathbf{B} = \gamma(\mathbf{L} \times \mathbf{B})$$

The angular momentum L precesses about the direction of \mathbf{B} with a Larmor angular frequency

$$\boldsymbol{\Omega} = (-\gamma)\mathbf{B}$$

From the figure, we get

$$d\mathbf{L} = (-\gamma)LB \sin \theta (\mathbf{e}_\phi) dt$$

where θ is the angle between \mathbf{B} and L , and \mathbf{e}_ϕ is the unit vector. The magnitude of dL is equal to $L \sin \theta (d\phi)$;

$$L \sin \theta d\phi = (-\gamma)LB \sin \theta dt$$

or

$$\frac{d\phi}{dt} = \Omega = (-\gamma)B$$

