

Simulation III: Adaptive Networks

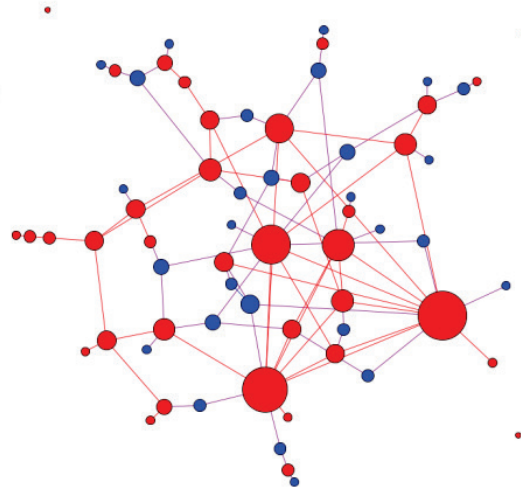

Hiroki Sayama
sayama@binghamton.edu

A map of network science

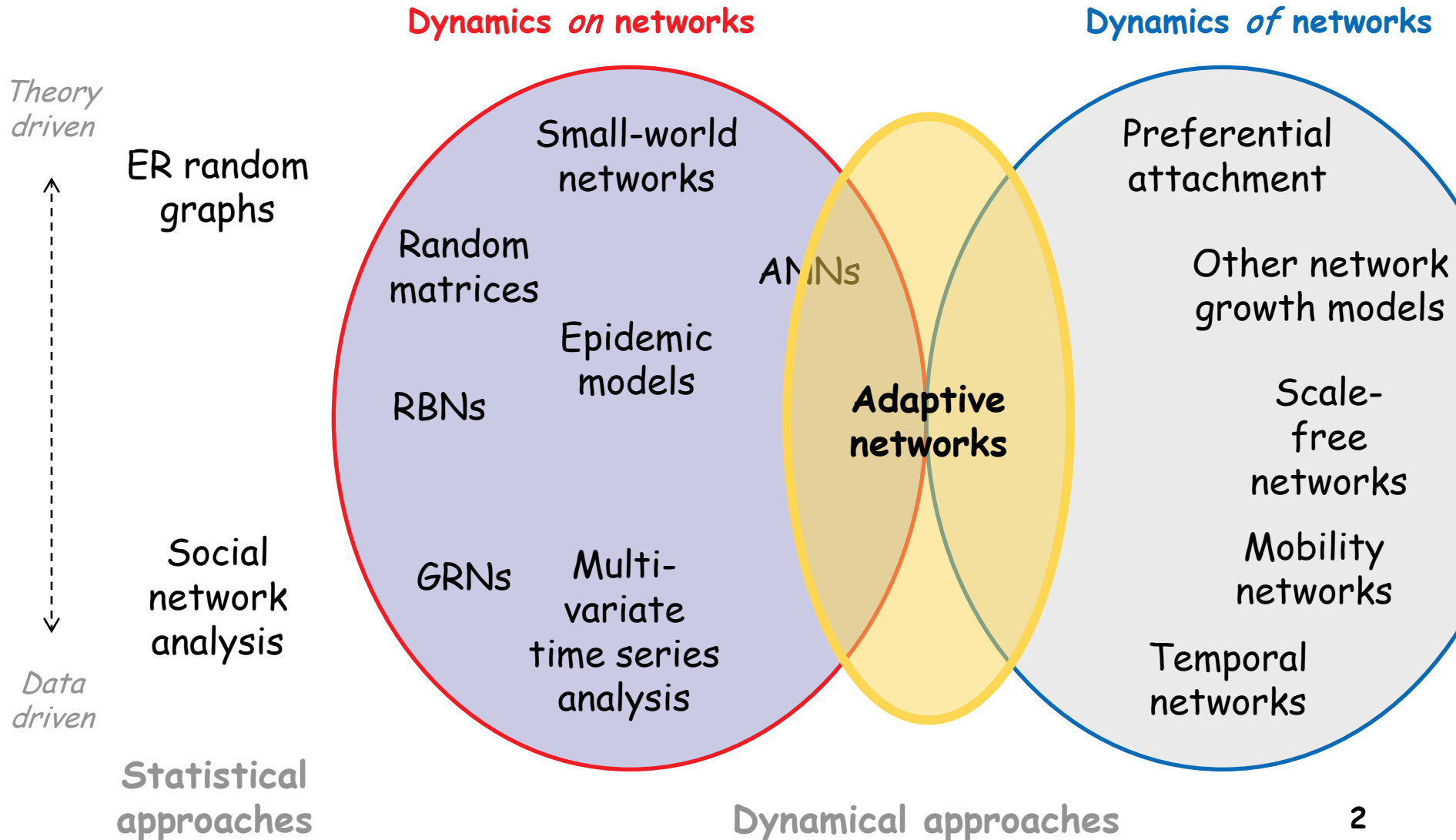

Adaptive networks

- **Complex networks whose states and topologies co-evolve, often over similar time scales**
 - **Link (node) states adaptively change according to node (link) states**

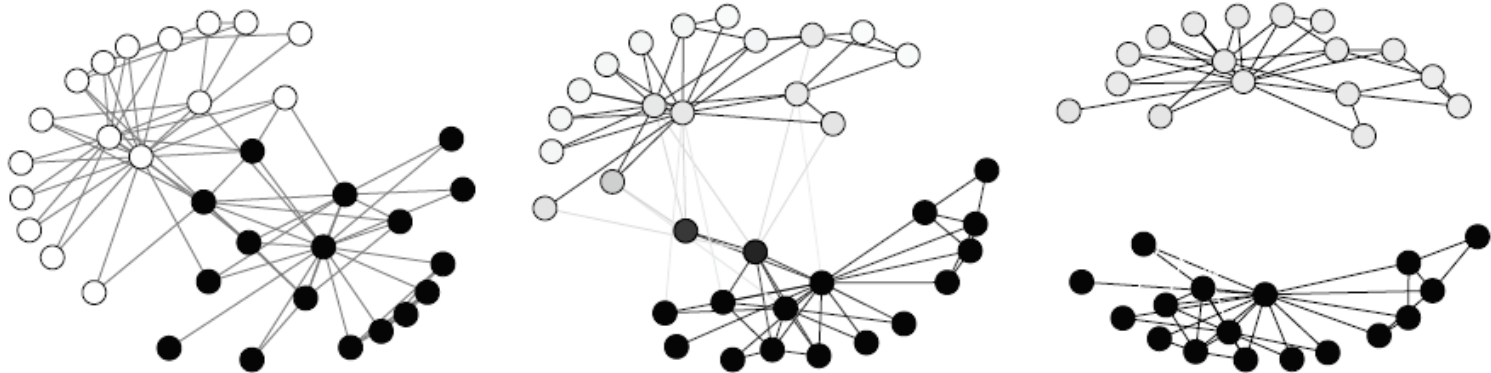

Adaptive networks in action

- Many real-world complex systems show coupling between “dynamics of networks” and “dynamics on networks”
-

System	Nodes	Edges	States of nodes	Topological changes
Organism	Cells	Intercellular communication channels	Gene/protein activities	Fission and death of cells during development
Ecological community	Species	Interspecific relationships	Population	Speciation, invasion, extinction of species
Human society	Individual	Conversations, social relationships	Social, professional, economical, political, cultural statuses	Changes in social relationships, entry and withdrawal of individuals
Communication network	Terminals, hubs	Cables, wireless connections	Information stored and transacted	Addition and removal of terminal or hub nodes

Simulation of Adaptive Networks

Simulating state-topology coevolution

- Technically, very easy; not so much different from other network simulation models
- One minor problem:
How to handle topological changes while state changes are also ongoing?
→ Asynchronous updating

Example: Epidemics on adaptive networks

- Original epidemic network model
+ adaptive changes of links
- A susceptible node that has a link to an infected node will cut the link and reconnect it to another susceptible node with probability p_c
- Does the disease stay in the network?

Exercise

- Study the effects of rewiring probability on the disease fixation on and the global network structure of an initially random social network
 - In what condition will the disease remain within society?
 - How will the topology of the network be reformed through the disease propagation process?

Example: Adaptive voter model

- Original voter model
 - + adaptive disconnection of links
- A link that connects two nodes with different opinion states may be cut with probability p_c
- How will the social network and opinions evolve?

Exercise

- Study the effects of the link disconnection probability on the consensus formation in the adaptive voter model
 - Plot the final number of opinions as a function of p_c
 - How will the topology of the network be changed by the diversity of opinions?

Example: Adaptive diffusion model

- Original diffusion model
 - + adaptive disconnection of links
- Link weights will increase or decrease based on the similarity/dissimilarity of node states across the links
 - Conceptually similar to the adaptive voter model

Application 1: Corporate merger

- Modeling and simulation of cultural integration in two merging firms

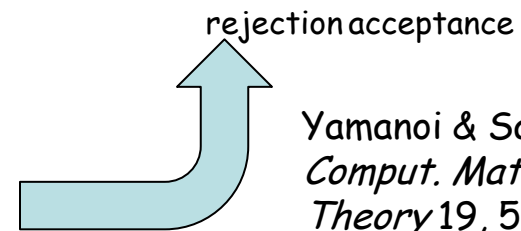
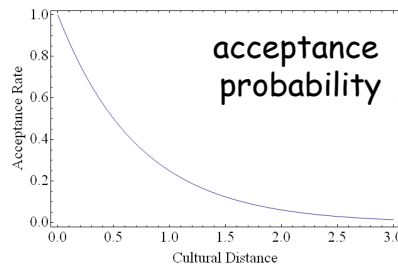
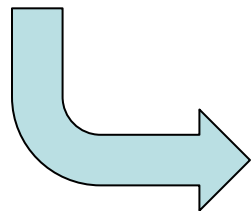
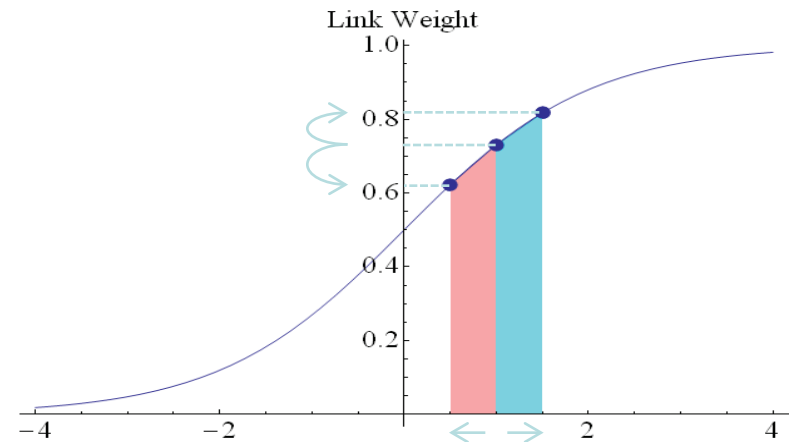
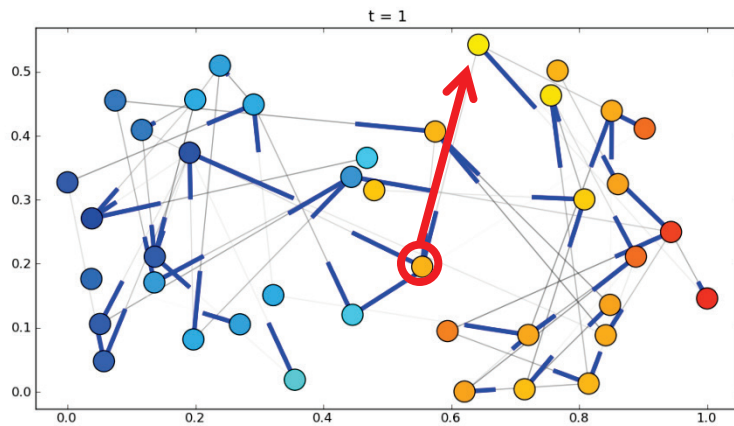

Yamanoi & Sayama,
*Comput. Math. Org.
Theory* 19, 516-537,
2013.

“Within-firm” concentration (w)

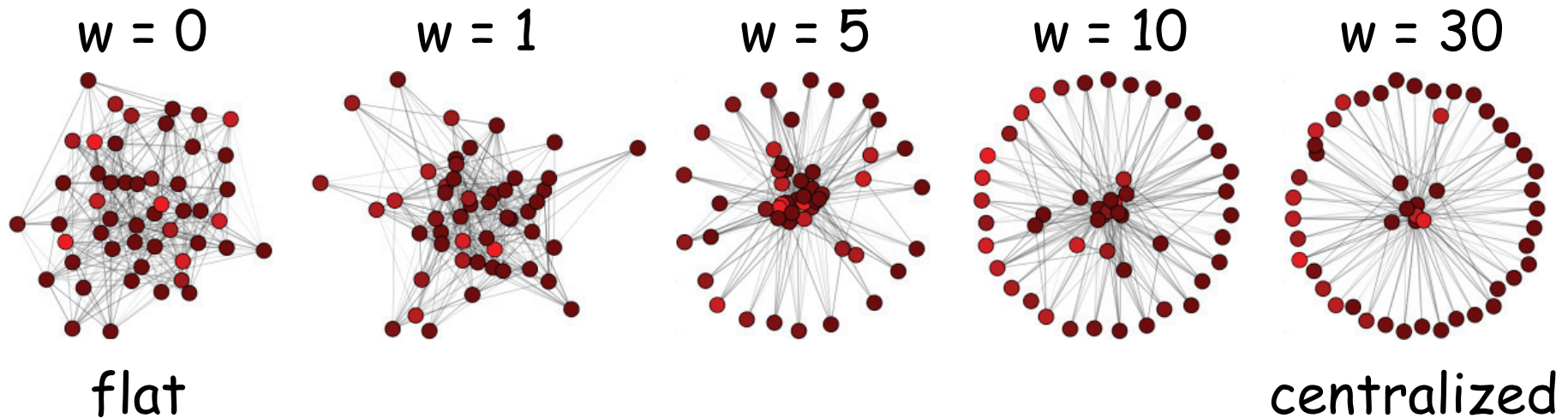

- Prob. for node i to become an info source:

$$P_w(i) \sim (i/n)^w \quad (i = 1, 2, \dots, n; \quad n = \text{firm size})$$

“Between-firm” concentration (b)

b = 0.1

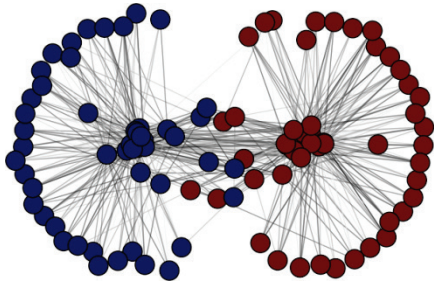

nearly random

b = 1

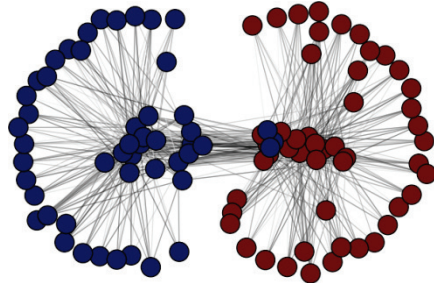

b = 3

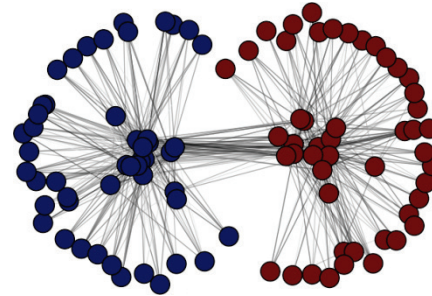

b = 5

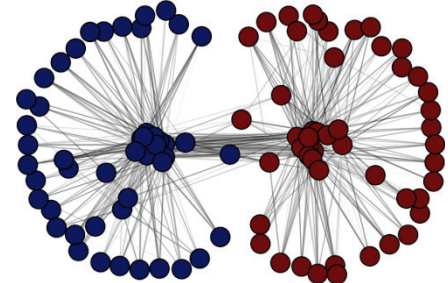

executive-level

- Prob. for node i to have an inter-firm tie:

$$P_b(i) \sim c_i^b$$

(c_i = within-firm closeness centrality of i)

Cultural distance

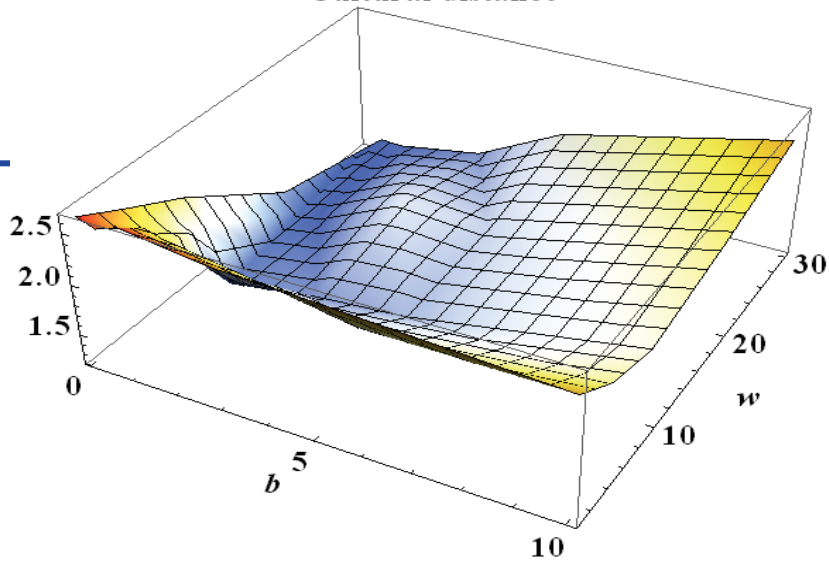

Turnover

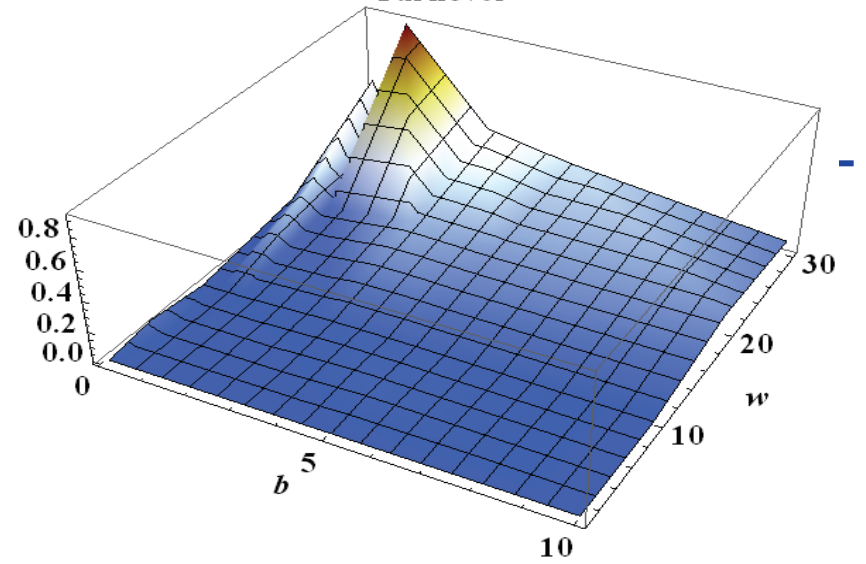

Interpersonal conflict

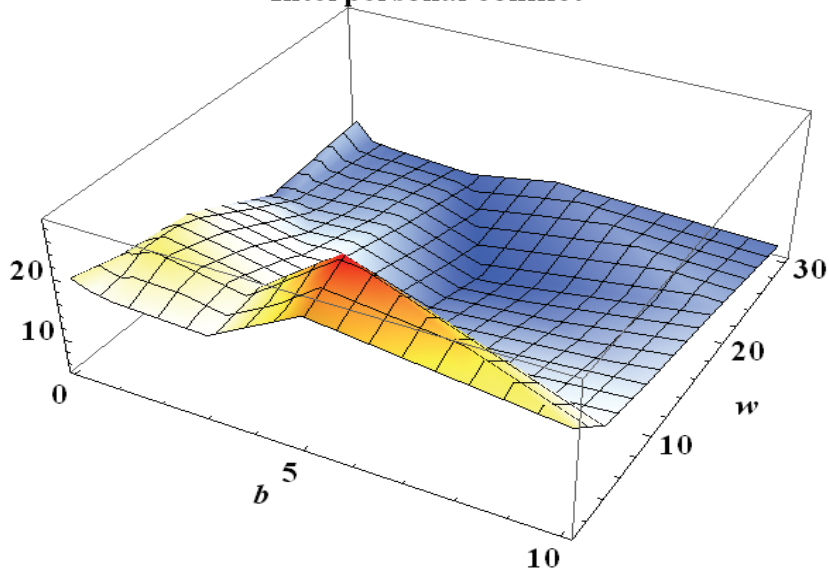

Organizational communication ineffectiveness

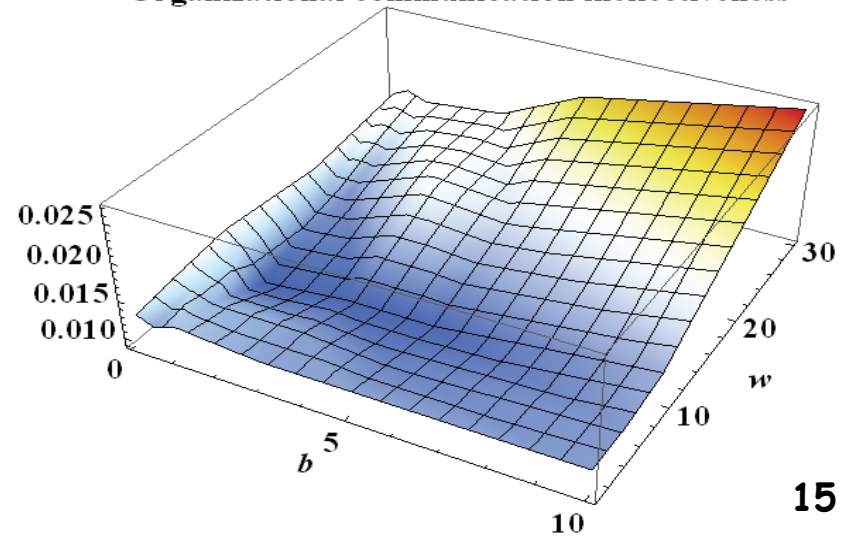

Application 2: Social diffusion and global drift

- Sayama & Sinatra, PRE 91, 032809, 2015

$$\frac{ds_i}{dt} = c(\langle s_j \rangle_j^i - s_i)$$



Adaptive link weight adjustment:

$$\frac{da_{ij}}{dt} = a_{ij} \left[\alpha \frac{s_i + s_j - 2\langle s \rangle}{2\sigma_s} - \beta \frac{(k_i - \langle k \rangle)(k_j - \langle k \rangle)}{\sigma_k^2} \right]$$

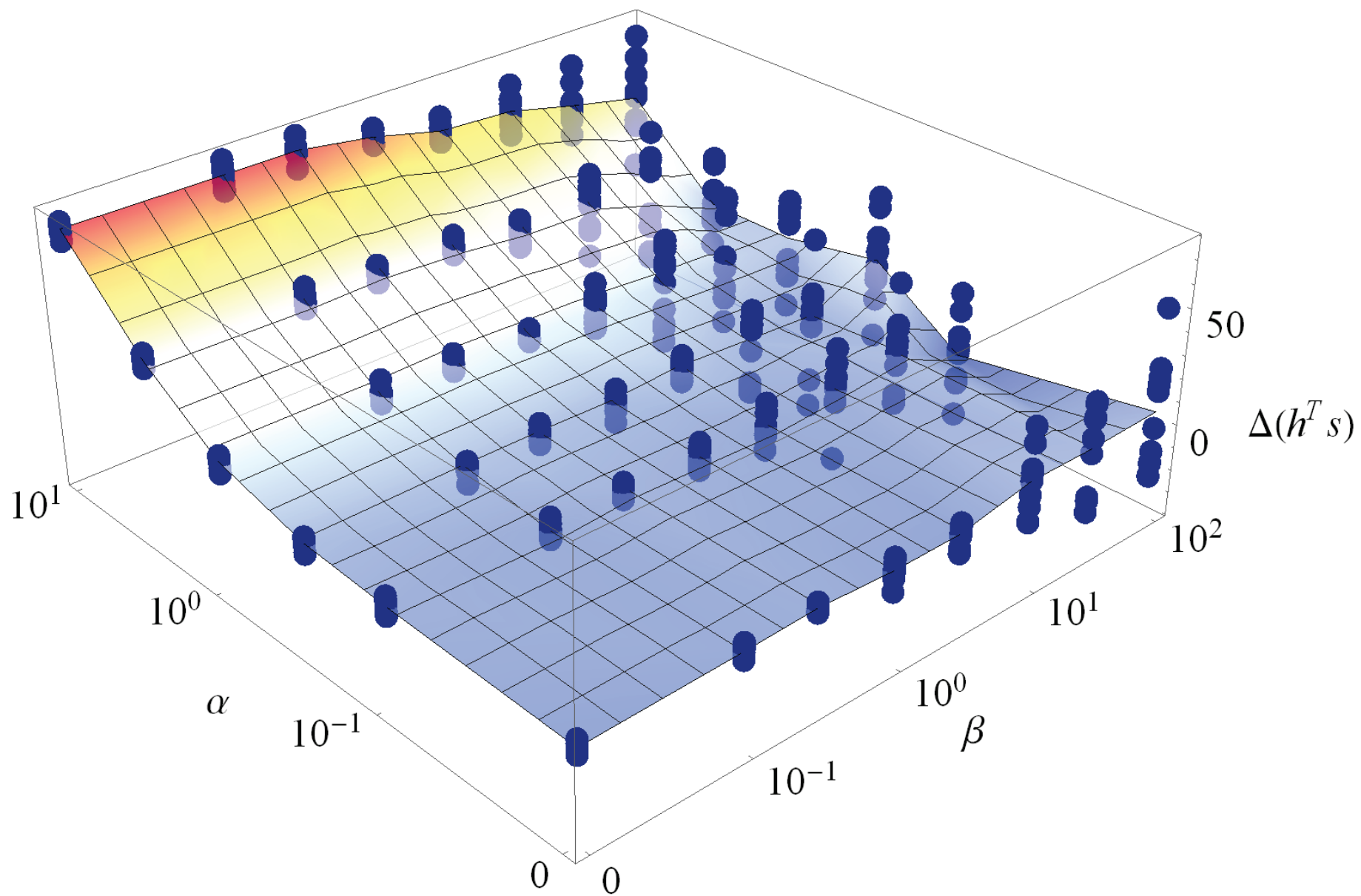

Exercise

- **Change the rule of link weight adjustment in the adaptive diffusion model**
 - E.g., Sayama & Sinatra (2015)
- **Simulate the revised model and see how the network topology and state co-evolve**

Theoretical Framework: Generative Network Automata

Generative network automata

- Unified representation of dynamics *on* and *of* networks using graph rewriting
- Defined by $\langle E, R, I \rangle$:
 - E : Extraction mechanism — When, Where
 - R : Replacement mechanism — What
 - I : Initial configuration

Sayama, Proc. 1st IEEE Symp. Artif. Life, 2007, pp.214-221.

GNA rewriting example

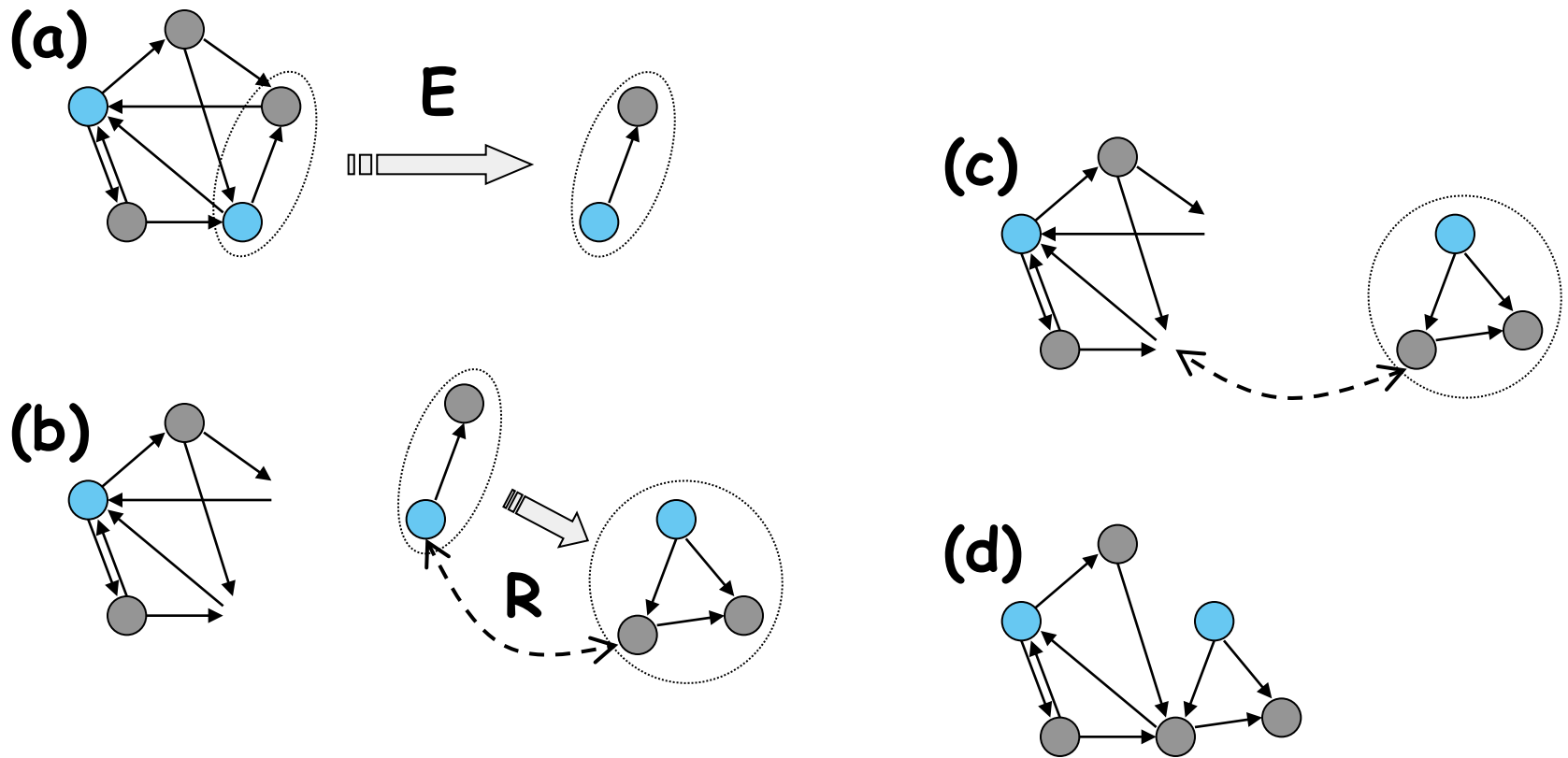

Actually, it's a generative network automata-on

E :
Extraction
mechanism

R:
Replacement
mechanism

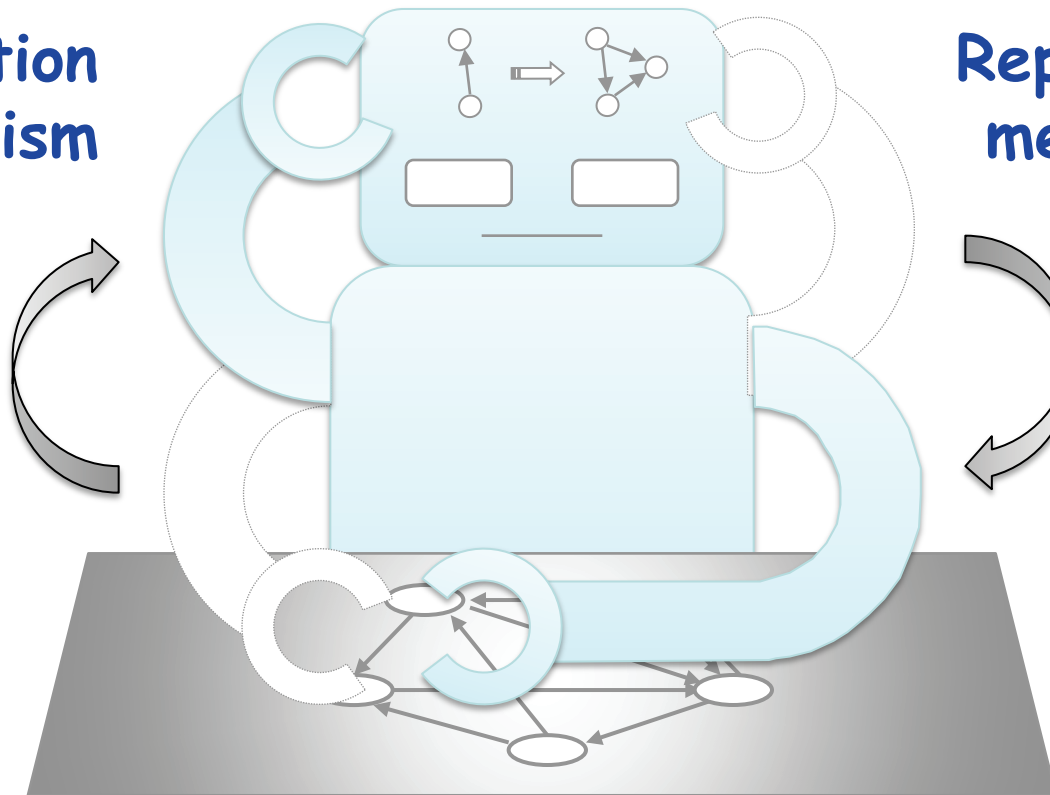

Generality of GNA

- GNA can uniformly represent in $\langle E, R, I \rangle$:
 - Conventional dynamical systems models
 - If R always conserves local network topologies and modifies states of nodes only
 - E.g. cellular automata, Boolean networks
 - Complex network generation models
 - If R causes no change in local states of nodes and modifies topologies of networks only
 - E.g. small-world, scale-free networks

Cellular automata

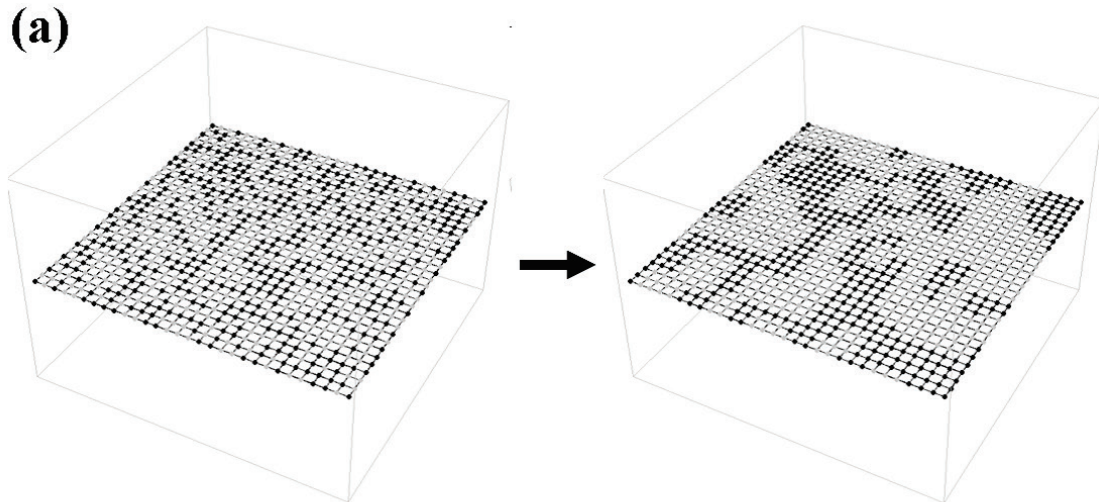

Random Boolean network

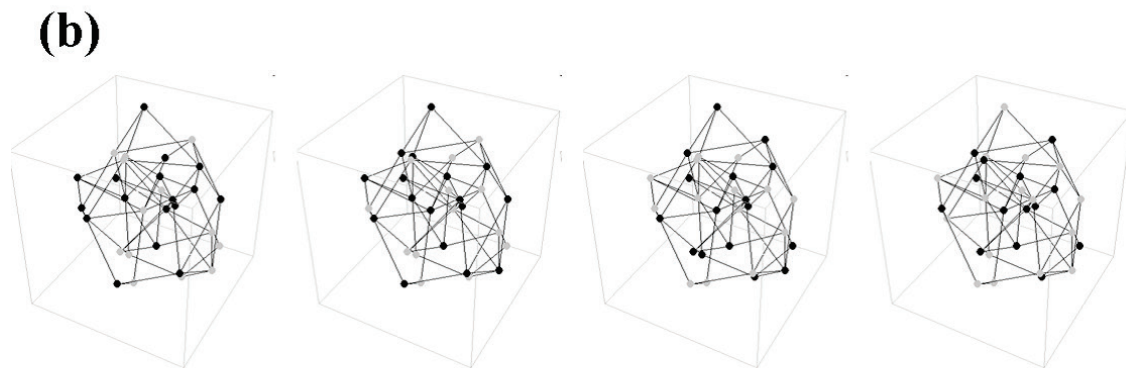

BA scale-free network

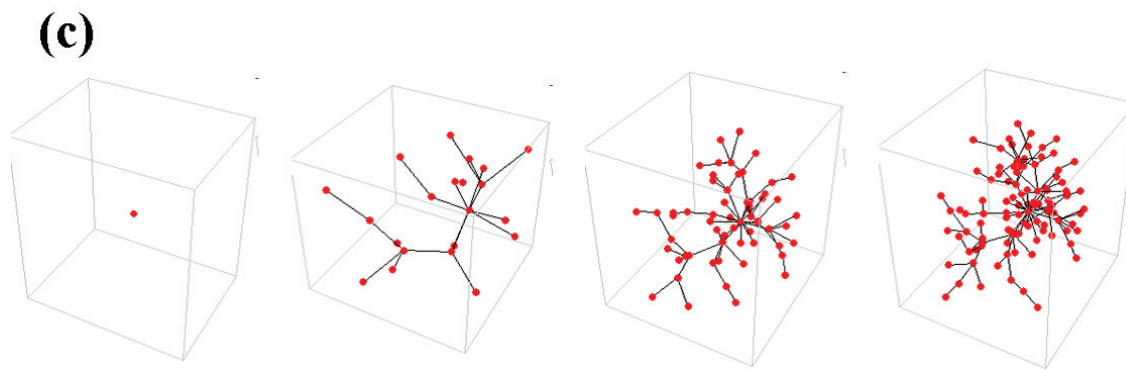

Exhaustive search of rules

- E samples a node randomly and then extracts an induced subgraph around it
- R takes 2-bit inputs (states of the node and neighbors) and makes 1-out-of-10 decisions

- Total number of possible R's: $10^{2^2} = 10,000$

- “Rule Number” $rn(R)$ is defined by

$$rn(R) = a_{11} 10^3 + a_{10} 10^2 + a_{01} 10^1 + a_{00} 10^0$$

- $a_{ij} \in \{0, 1, \dots, 9\}$: Choices of R when state of u is i and local majority state is j

Exhaustive search of rules

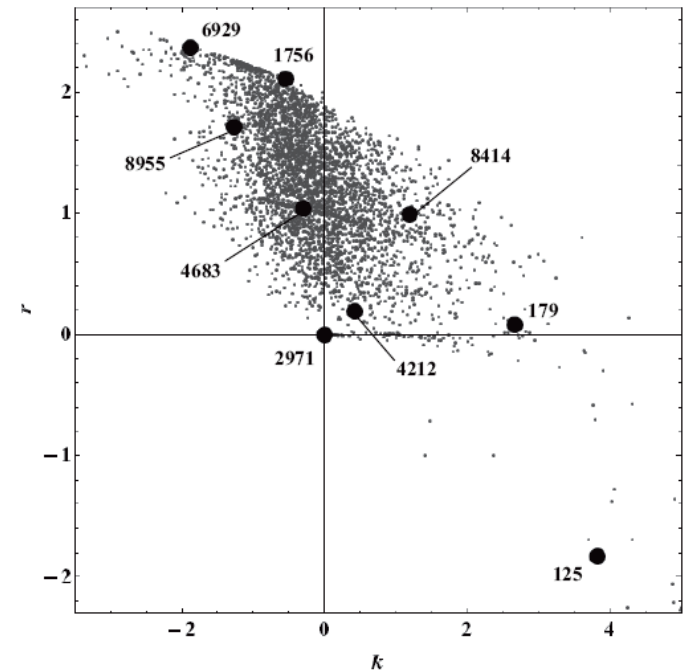
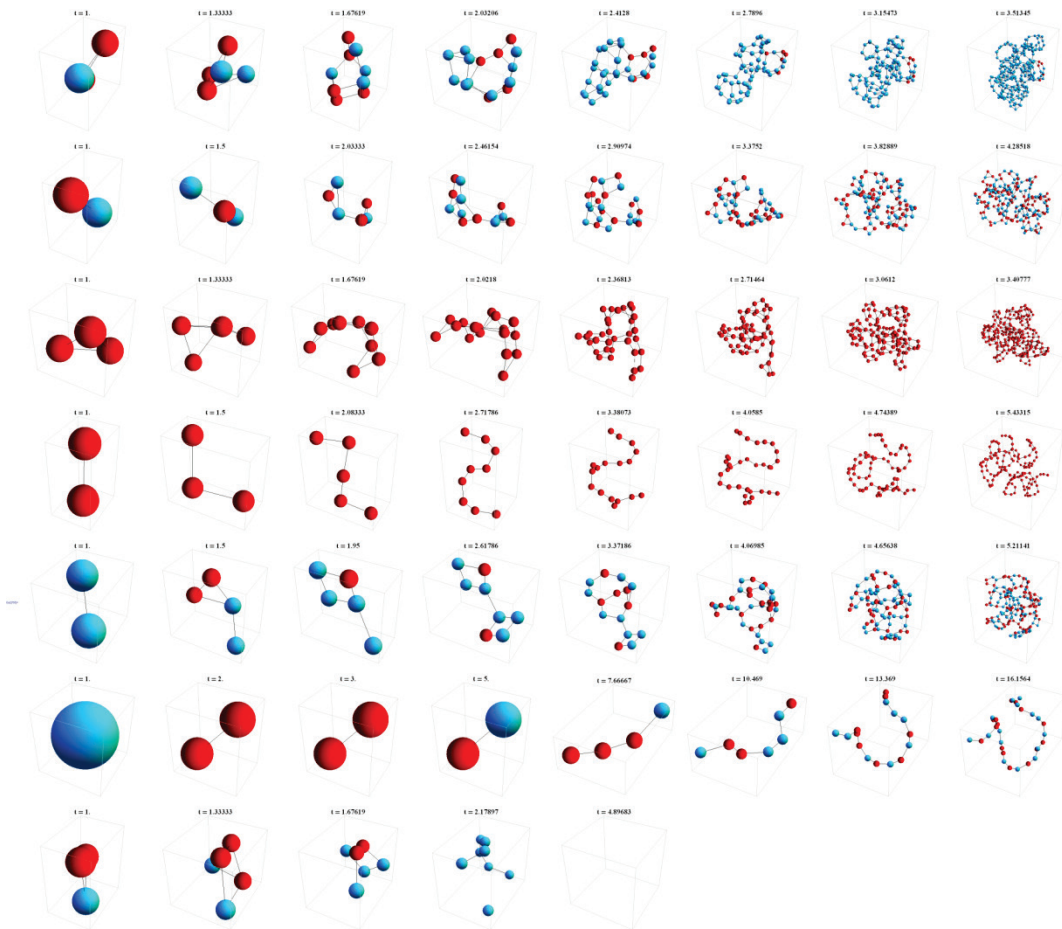

Sayama & Laramée, *Adaptive Networks*, Springer, 2009, pp.311-332.

Developing Adaptive Network Models from Empirical Data

A challenge

- How to derive a set of dynamical rules directly from empirical data of network evolution?
- Separation of extraction and rewriting in GNA helps the rule discovery

Pestov, Sayama, & Wong, *Proc. 9th Intl. Conf. Model. Simul. Visual. Methods*, 2012.

Schmidt & Sayama, *Proc. 4th IEEE Symp. Artif. Life*, 2013, pp.27-34.

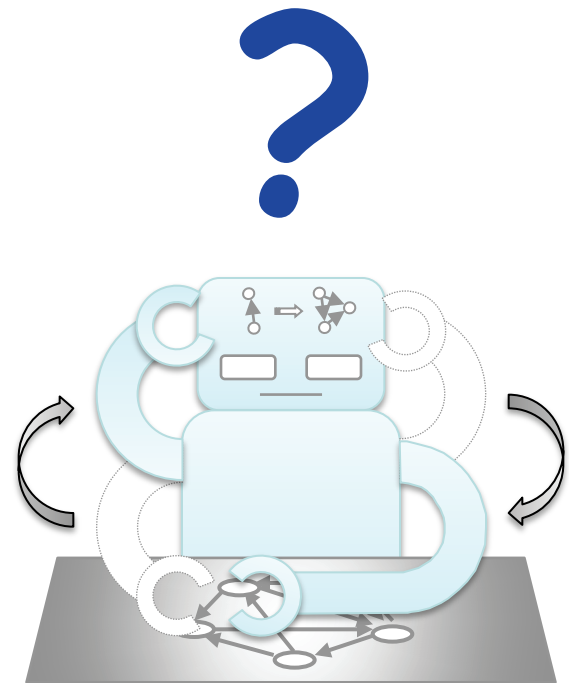

Application to operational network modeling

- **Canadian Arctic SAR (Search And Rescue) operational network**
 - Rewriting rules manually built directly from actual communication log of a December 2008 SAR incident
 - Developed a simulator for hypothetical SAR operational network development



a

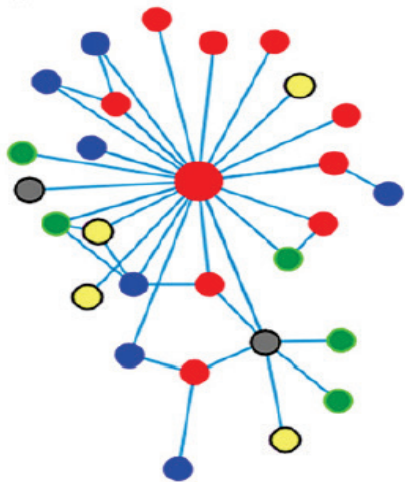

b

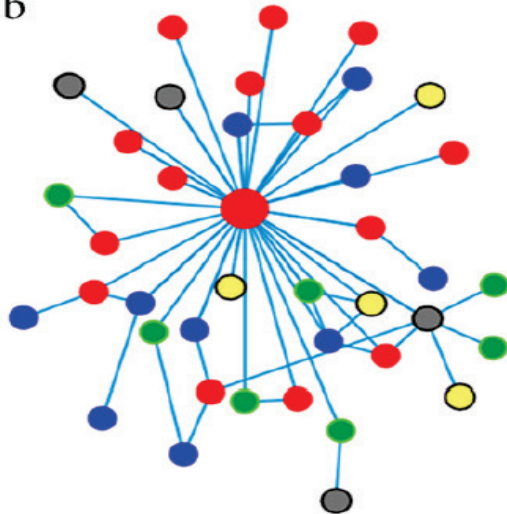

c

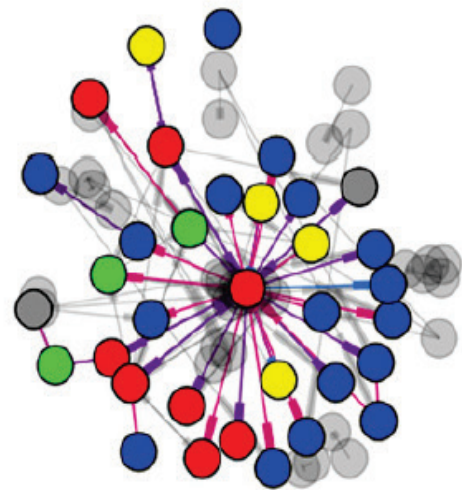
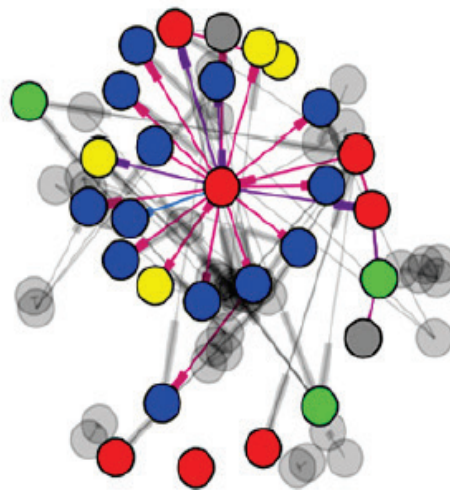
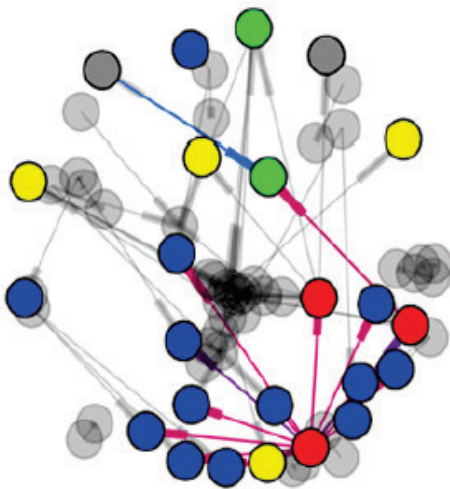
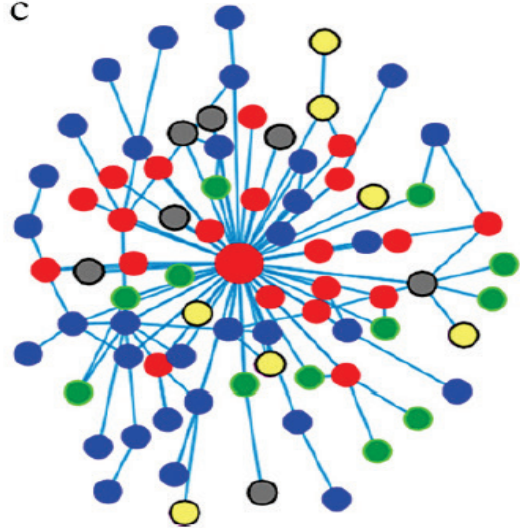

Automation of model discovery from data: PyGNA

- Adaptive network rule discovery and simulation implemented in Python
 - <https://github.com/schmidtj/PyGNA>
- Input: Time series of network snapshots
- Output: A GNA model that best describes given data

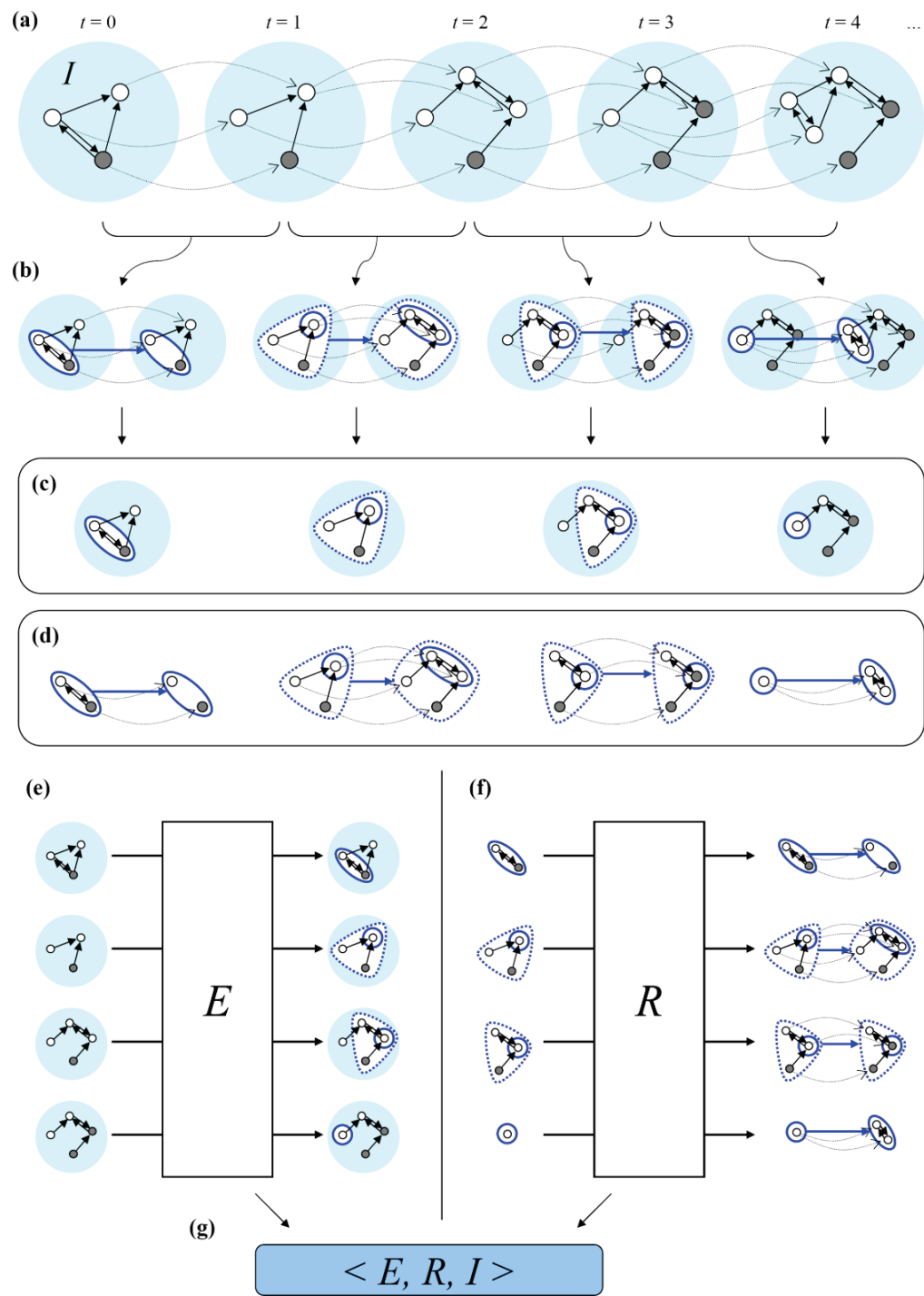

Extracted subgraphs

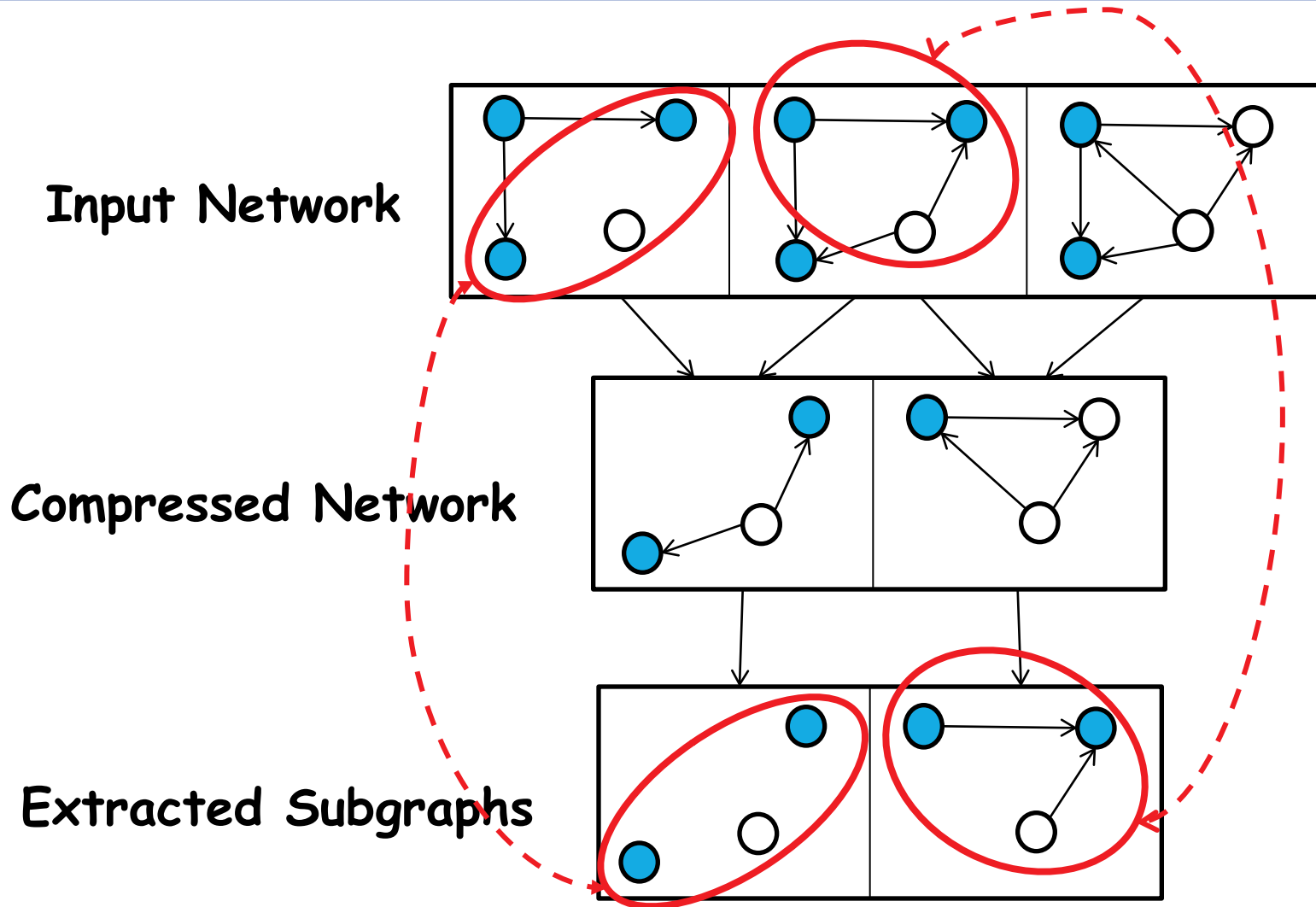

Extraction mechanism identification: “Where, when”

- **Candidate models provided by user**
 - Degree-based preferential selection
 - State-based preferential selection
 - Degree & State-based etc...
- **Maximum likelihood method**
 - Computes likelihood using each hypothetical model & accumulates log likelihood over time
 - Chooses the model with maximum likelihood

Algorithm

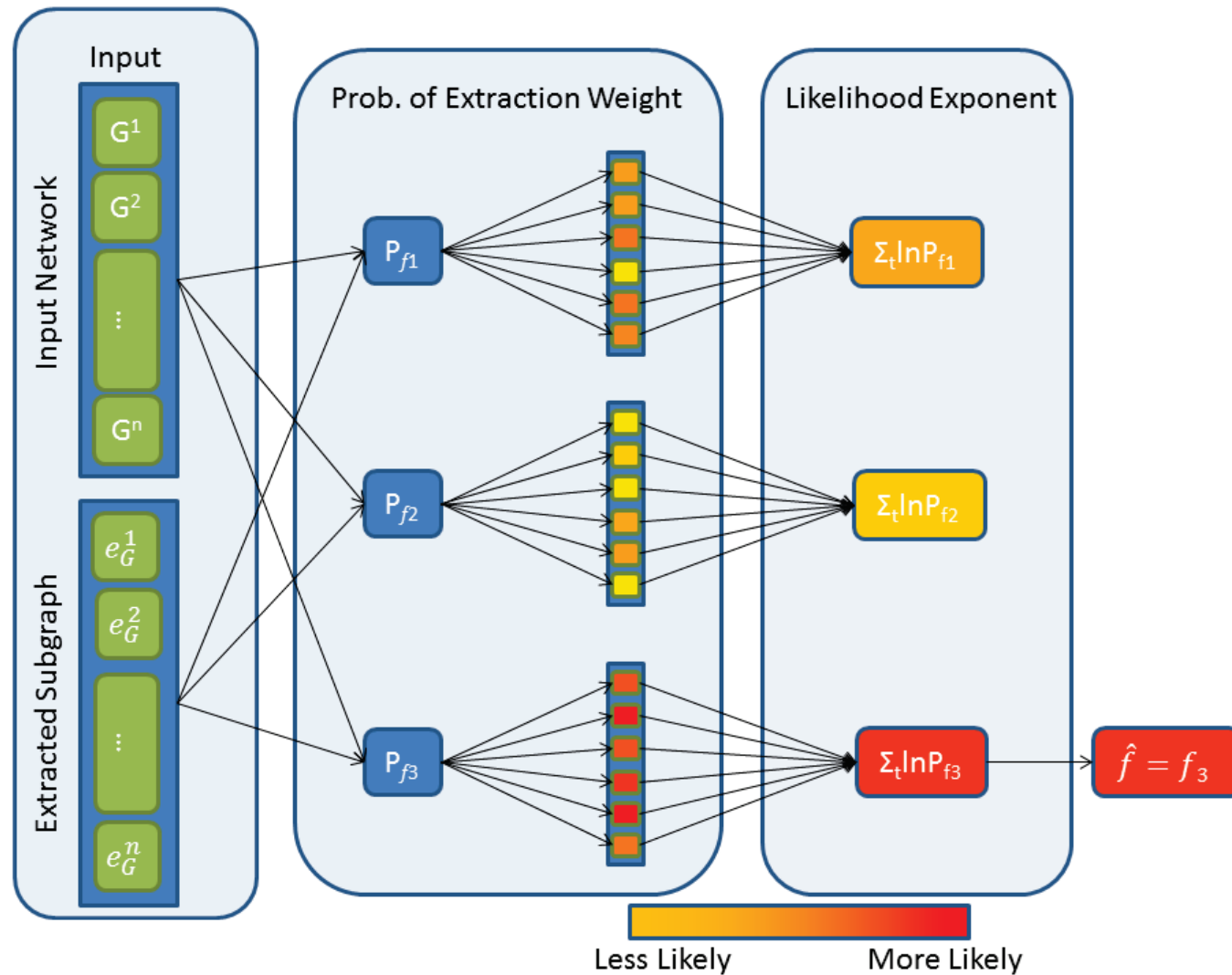

Replacement mechanism identification: "What"

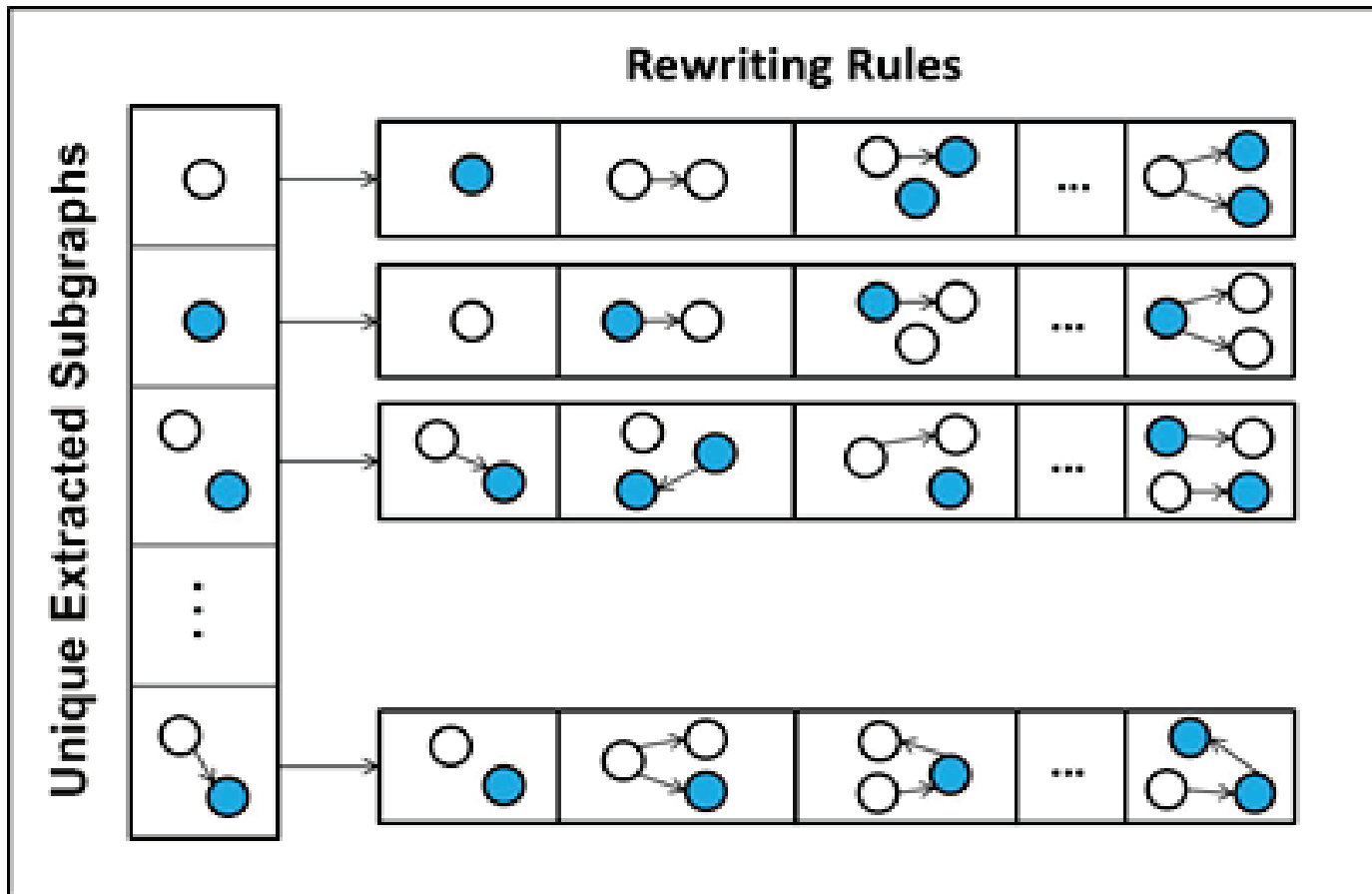

Algorithm

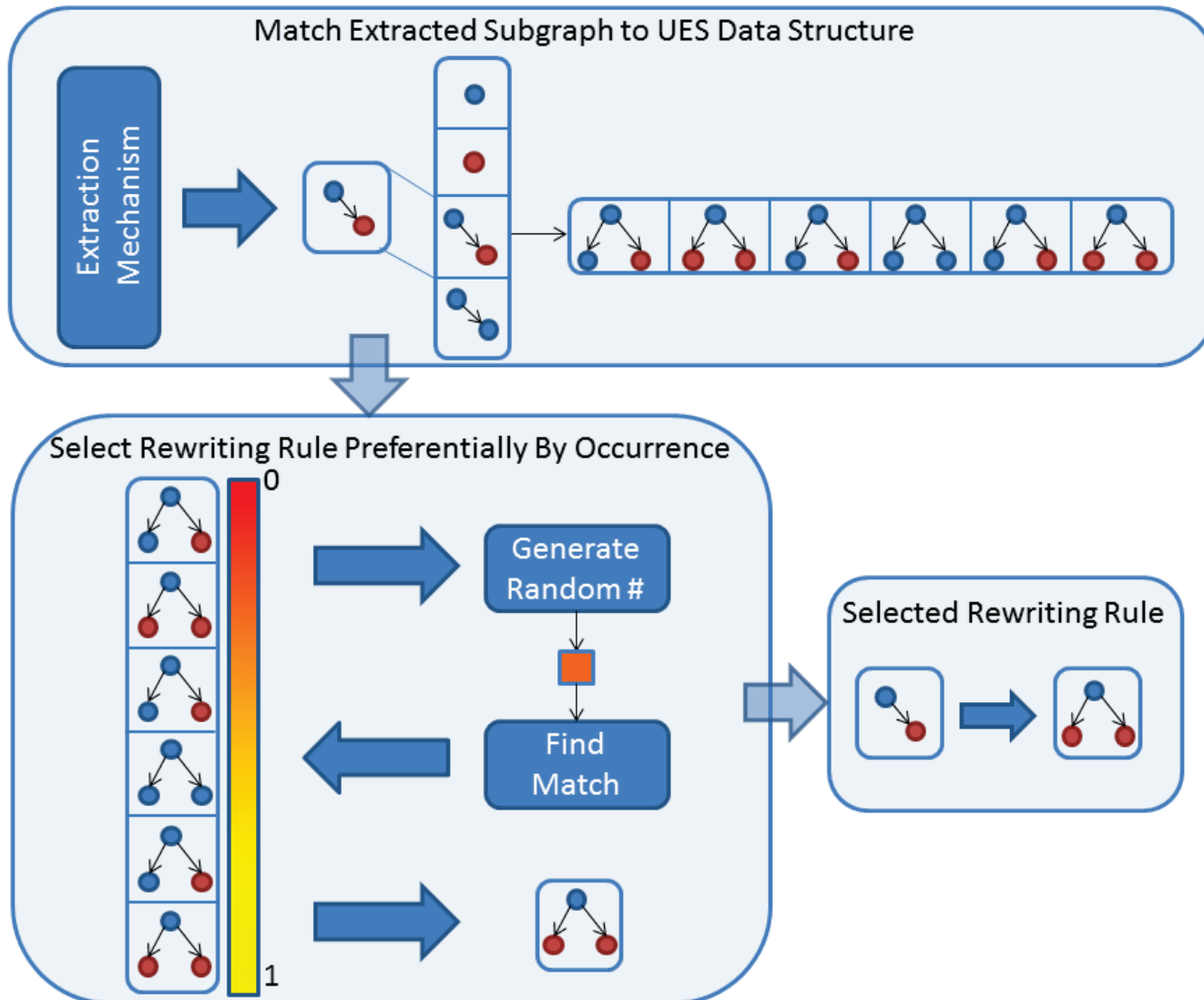

Results

- Example: "Degree-state" networks

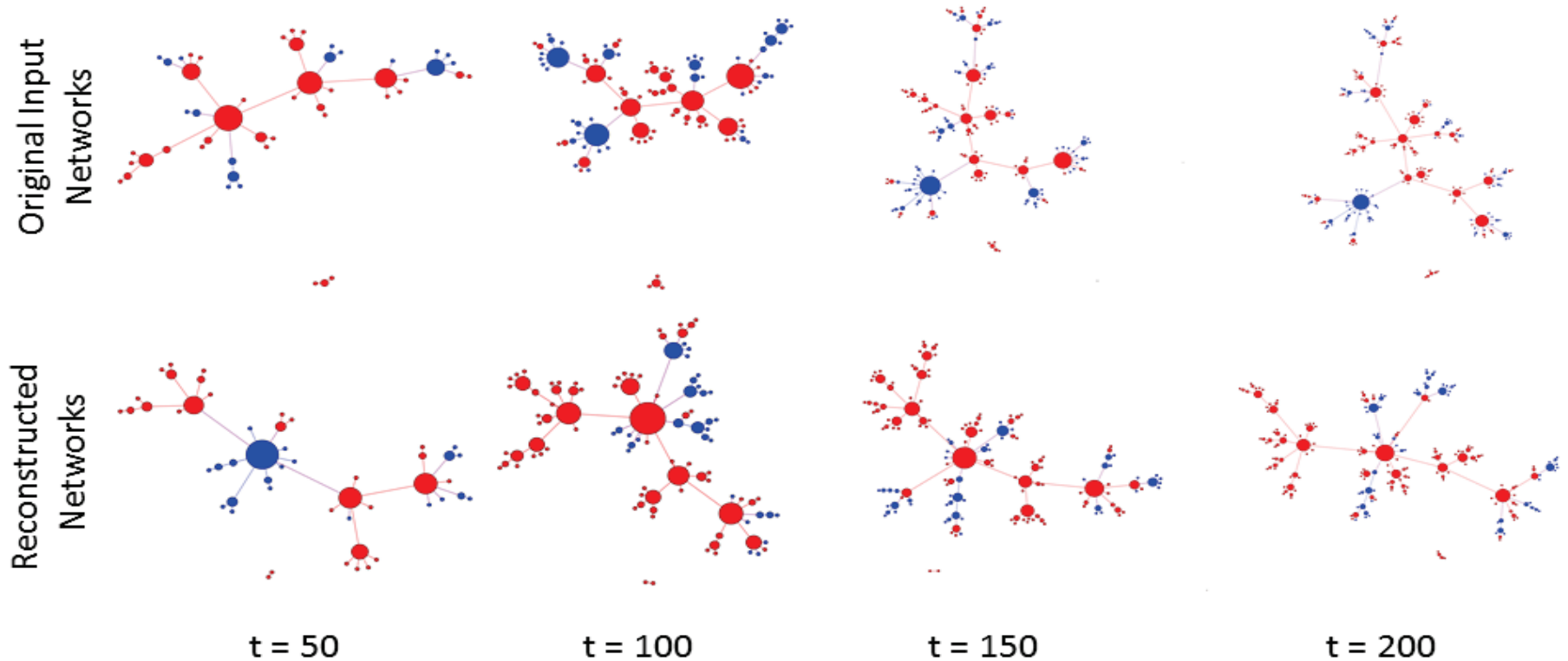

State-based

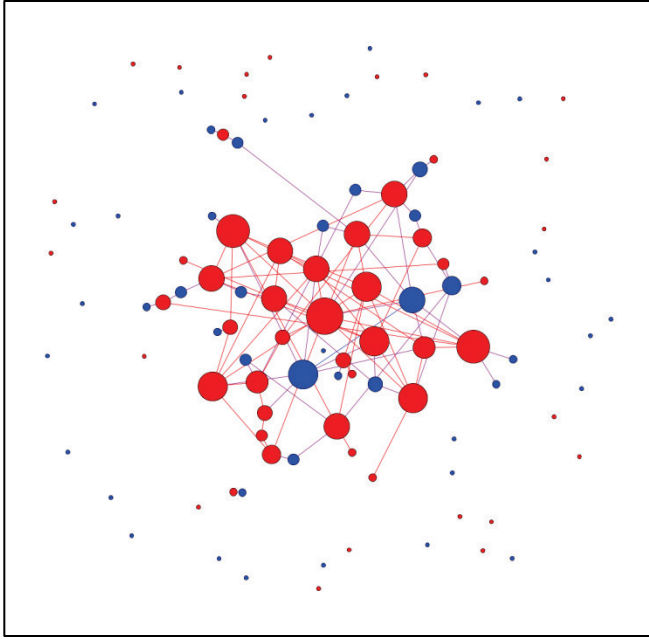

Input

Barabási-Albert

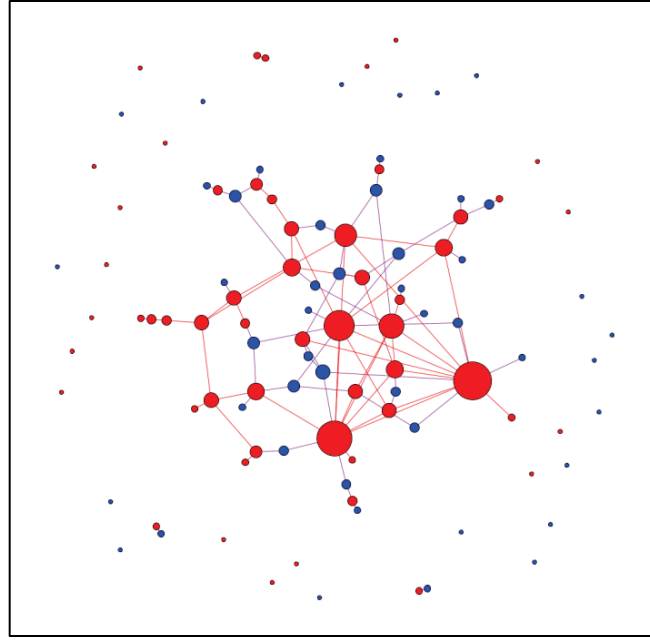
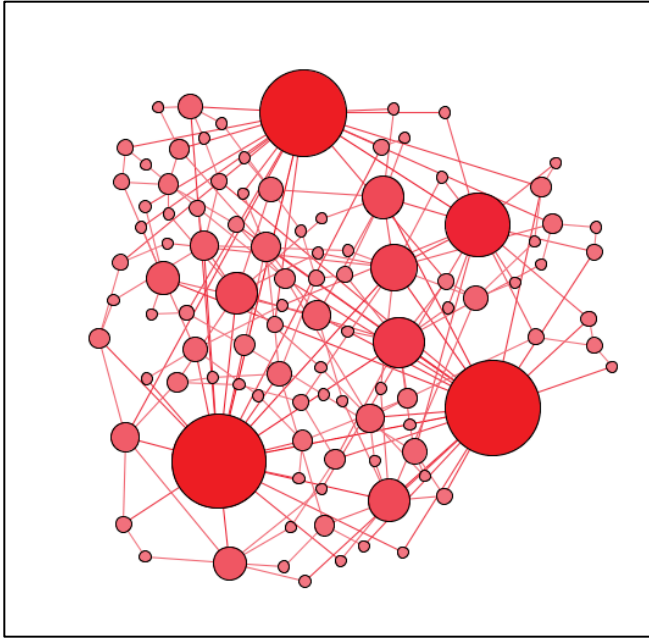

Simulated

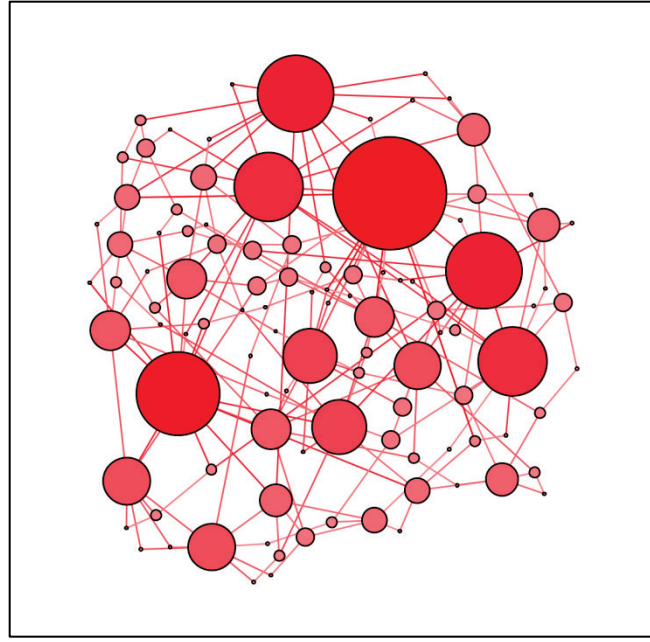

Forest Fire

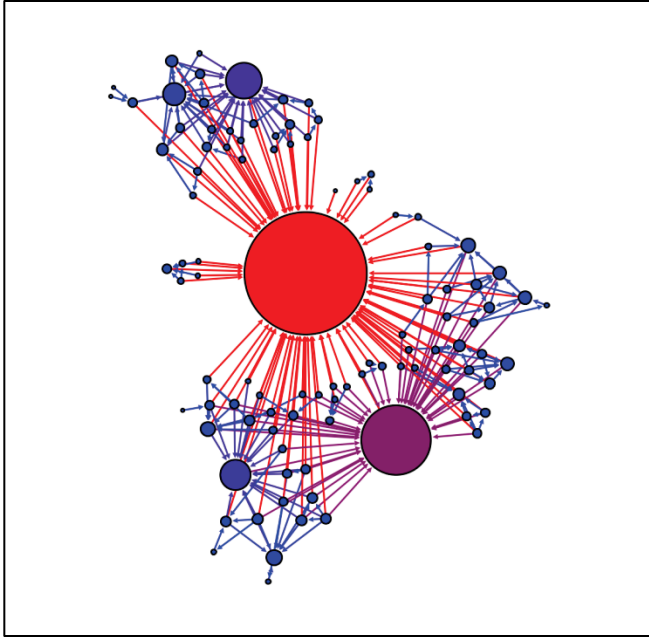

Input

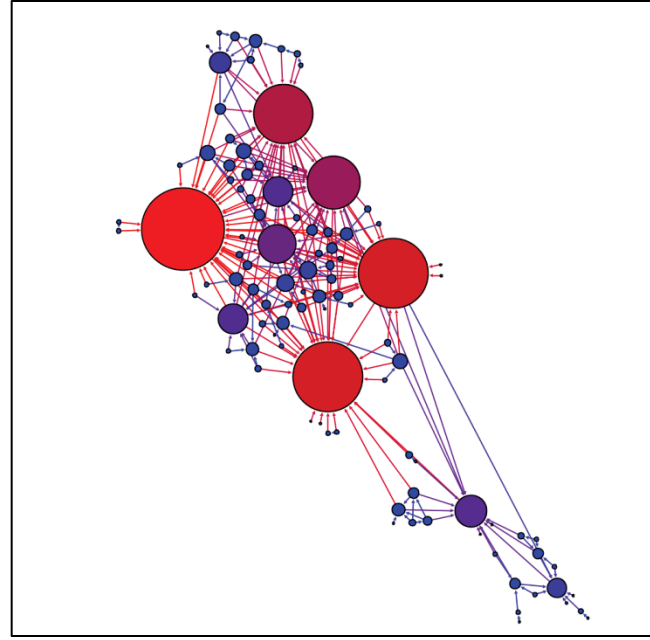

Simulated

Degree-State

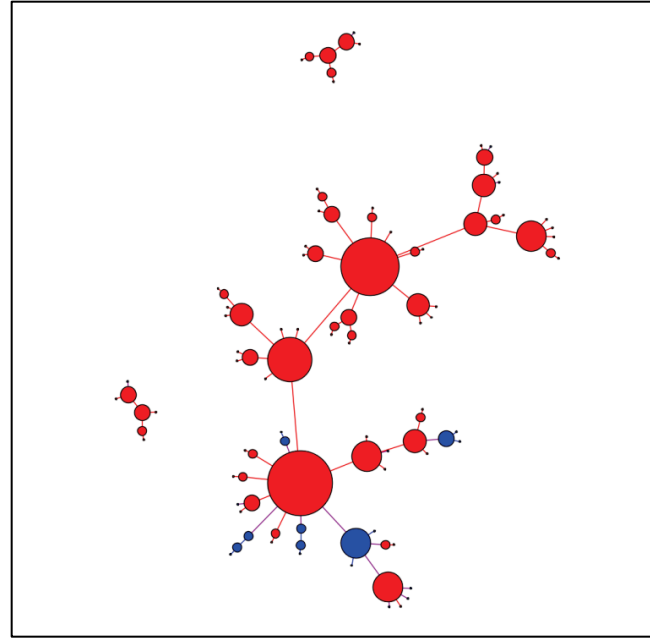
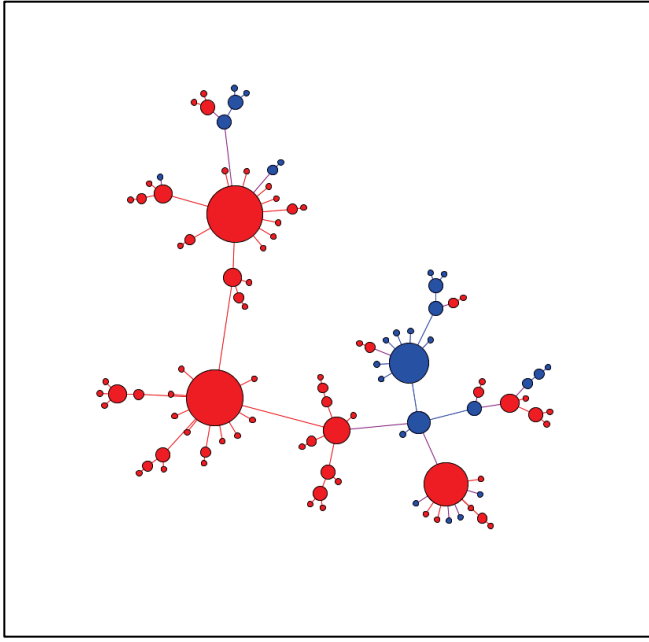

Barabási-Albert

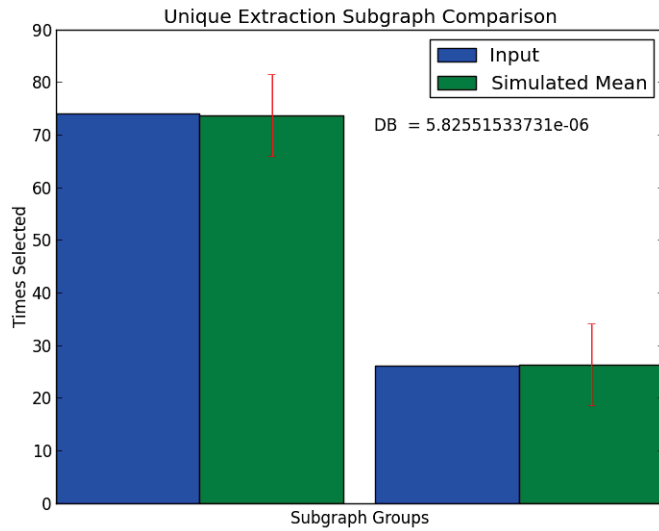

Degree-state

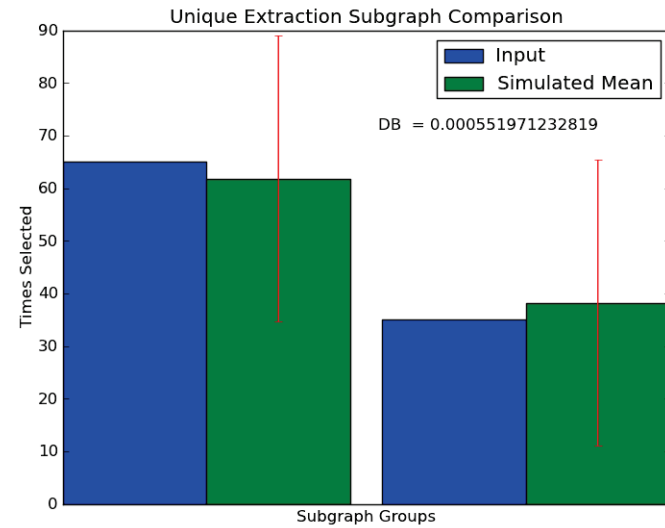

State-based

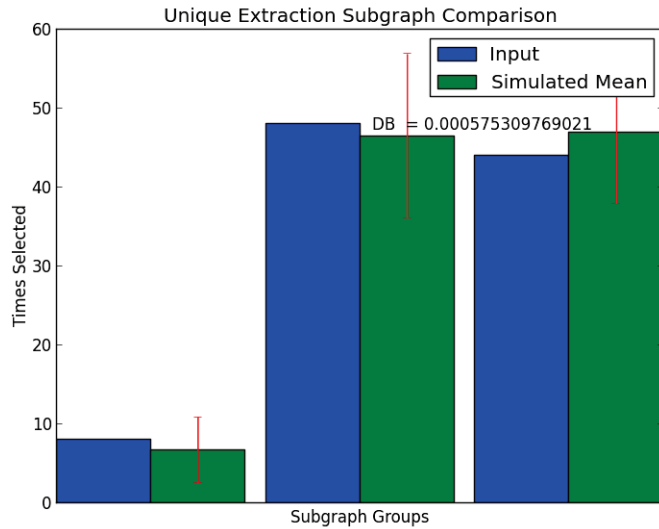

Forest Fire

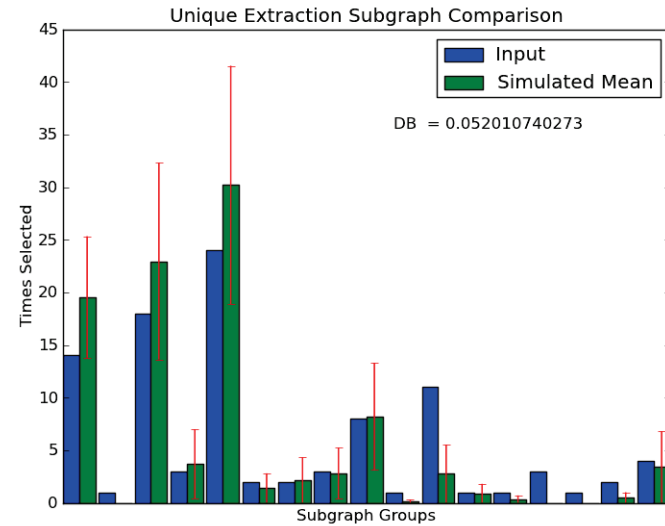

Comparison with other methods

- PyGNA produces *generative models* using detailed state-topology information
 - Capable of generative simulation that is not available in statistical approaches (e.g., Rossi et al. 2013)
- PyGNA models extraction and replacement as *explicit functions*
 - More efficient and flexible than graph-grammars (e.g., Kurth et al. 2005)

What can we do?

- Prediction

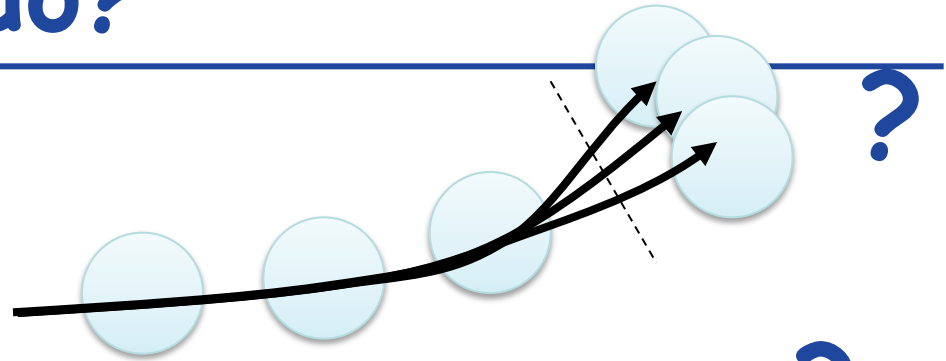

- Classification

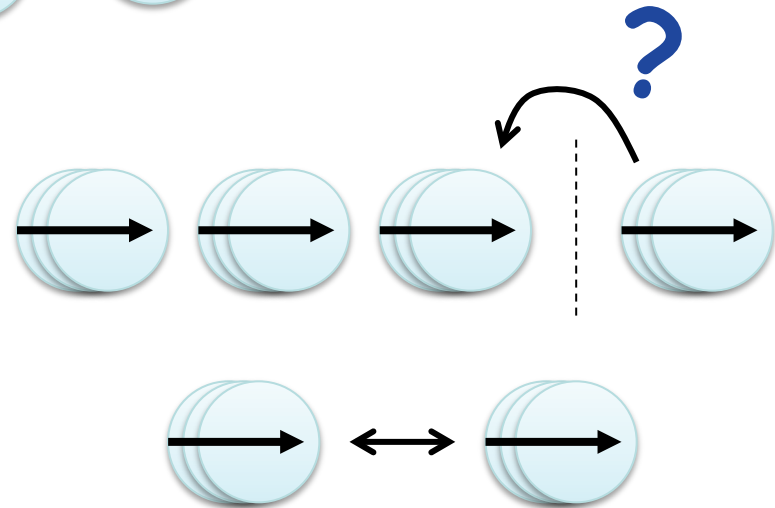

- Anomaly detection

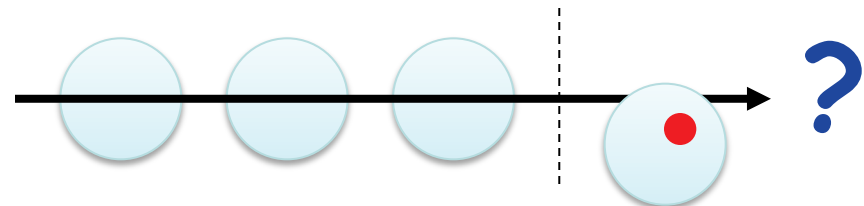

Summary

- State-topology coevolution of adaptive networks is a promising, unexplored area
 - Theory-driven approaches
 - Dynamical modeling, exhaustive rule search
 - Applications to social sciences etc.
 - Data-driven approaches
 - Application to operational network modeling
 - Automatic rule discovery from data

<http://coco.binghamton.edu/NSF-CDI.html>

Additional Topic:
Analysis of Adaptive Networks

How to analyze adaptive network dynamics?

- Non-trivial coupling between network states and topologies are not easily handled in a simple analytical formula
- But such couplings could be partially incorporated in analysis by considering densities of node “pairs”

Pair approximation

- Considers densities of every pair of nodes with states & connectivity (in addition to individual state densities)

ρ_{00c} = density of 

ρ_{01c} = density of 

ρ_{11c} = density of 

ρ_{00n} = density of 

ρ_{01n} = density of 

ρ_{11n} = density of 

Describes
how these
densities
change over
time

Example: Adaptive voter model

- Disconnect of a link:

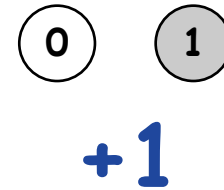
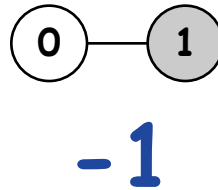
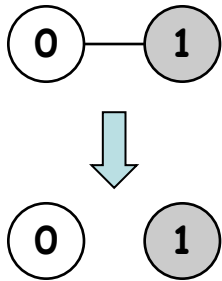

- Change of an opinion:

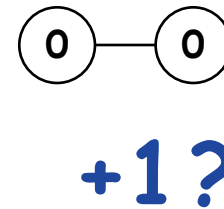
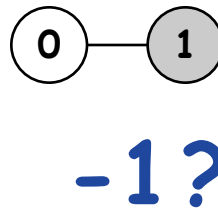
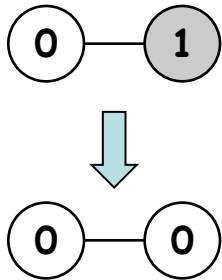

(Any other densities affected too?)

Exercise

- Complete the number of changes in each pair density for the adaptive voter model on a random network
- Calculate how often each transition occurs
- Make a prediction using the pair-approximation-based model

Exercise

- Conduct pair approximation of the adaptive SIS model and study its dynamics

FYI: Moment closure

- Similar approximations are possible for densities of higher-order motifs
- Approximation techniques (including MFA, PA and higher-order ones) is called the “**moment closure method**”
 - Predicting the change of a “moment” (ρ_{00}) would require higher-order “moments” (ρ_{000}), but you “close” this open chain by assuming $\rho_{000} = \rho_{00} \rho_{00} / \rho_0$, etc.